

CHAPTER FOUR

profiles

	PVC PROFILES FOR LIGHTBOXES	Date
Pag. 4.01	SYSTEM 4	May 2026
Pag. 4.02	SYSTEM L	May 2026
Pag. 4.03	MARTINA PROFILES	ON DEMAND
	ALUMINIUM PROFILES FOR LIGHTBOXES	
Pag. 4.07	NEX LINE PROFILES 80	November 2025
Pag. 4.08	NEX LINE PROFILES 120	November 2025
Pag. 4.09	NEX LINE PROFILES 150	May 2026
Pag. 4.10	NEX LINE PROFILES 170	November 2025
Pag. 4.11	NEX LINE PROFILES 200	November 2025
Pag. 4.12	PROFILES 80	April 2026
Pag. 4.13	PROFILES 120	April 2026
Pag. 4.14	PROFILES 150	April 2026
Pag. 4.15	PROFILES 163	April 2026
Pag. 4.16	PROFILES 186	May 2026
	PROFILES FOR SINGLE SIDE TEXTILE FRAMES	
Pag. 4.20	T-FLEX 9/1 RETROFIT	February 2025
Pag. 4.21	ECOPLUS SIMPLEX	June 2024
Pag. 4.22	ECOPLUS ACE	June 2024
	PROFILES FOR TEXTILE FRAMES AND STRUCTURES	
Pag. 4.25	ECOPLUS DAME	June 2024
Pag. 4.26	ECOPLUS KING	July 2023
4.26A	T-FLEX 46/2 BASIC	February 2025
Pag. 4.27	ECOPLUS 80	June 2024
	PROFILES FOR SINGLE SIDE TEXTILE LIGHTBOXES	
Pag. 4.30	ECOPLUS 55	February 2025
Pag. 4.31	ECOPLUS MAXI	March 2026
Pag. 4.33	T-FLEX 100	January 2026
Pag. 4.34	ECOPLUS 110	ON DEMAND
Pag. 4.35	T-FLEX 150	January 2026
	PROFILES FOR DOUBLE SIDE TEXTILE LIGHTBOXES	
Pag. 4.40	T-FLEX 96/2	January 2026
Pag. 4.40A	T-FLEX 120/2	January 2026
Pag. 4.41	ECOPLUS 120/2	February 2025
Pag. 4.42	ECOPLUS 160	ON DEMAND
Pag. 4.43	T-FLEX 170/2	January 2026
	PROFILES FOR TEXTILES TENSIONING	
Pag. 4.46	ECOPLUS 140	January 2021
Pag. 4.47	CRYSTAL	February 2026
Pag. 4.47B	EXTENTION WALL	March 2026
Pag. 4.48	KEE KLAMP JOINTS	December 2024
	TOTEM SYSTEM	
Pag. 4.50	TM100 PROFILES FOR 2 SIDES TOTEMS	May 2026
Pag. 4.51	TM500 PROFILES FOR 2 SIDES TOTEMS	February 2022
Pag. 4.52	TM600 PROFILES FOR 2 SIDES TOTEMS	February 2022
Pag. 4.53	TM300 PROFILES FOR 3 SIDES TOTEMS	May 2026
	PROFILES FOR RIGID PANELS	
Pag. 4.56	PANEL FRAME PROFILES	March 2026
Pag. 4.57	TERRACE	February 2025
Pag. 4.58	SQUAREFIX	May 2023
Pag. 4.58A	ACCESSORIES FOR SQUAREFIX	May 2023
Pag. 4.59	SYSTEM 25	May 2026
Pag. 4.59A	ACCESSORIES FOR SYSTEM 25	February 2022
Pag. 4.60	EDGETRIM ADHESIVE PROFILES FOR PANELS	February 2025

	STRIP LED PROFILES	
Pag.	4.65	M PROFILE
Pag.	4.66	R PROFILE
Pag.	4.67	F PROFILE
Pag.	4.68	B PROFILE
Pag.	4.69	S PROFILE
Pag.	4.70	P PROFILE
Pag.	4.71	D PROFILE
Pag.	4.72	H PROFILE
Pag.	4.73	G PROFILE
Pag.	4.74	TALEXX PROFILES Z200/Z201/Z22W
Pag.	4.75	N2008 PROFILE
	CHANNEL LETTERS PROFILES	
Pag.	4.78	JEWELITE F LETTER TRIM
Pag.	4.79	BOXLETTER CABLE CHANNEL
		March 2026
		March 2026
		March 2026
		March 2026
		March 2026
		March 2026
		March 2026
		April 2023
		August 2025
		ON DEMAND
		April 2026

GENERAL SALES CONDITIONS

INTRODUCTION

All the hereunder conditions are intended and accepted for each order you send to us.

Prices do not include VAT and extra fees eventually needed. Any change in prices will be agreed before the delivery.

1. ORDERS

All orders are accepted and executed on the basis of the following conditions, which will govern future deliveries, even when not reproduced.

All orders should be sent to us by fax or e-mail. Except in case of different agreements, we will debt a fixed contribution of € 15,00.

= (as partial reimbursement for bank and customs fees).

2. DELIVERIES

Goods are delivered at the buyer's risk.

Quoted times for delivery are not binding. Buyers cannot refuse the goods or ask for a reimbursement in case of delayed delivery.

3. COMPLAINTS AND RETURN OF GOODS

The client must check the condition of the goods upon its arrival and, in case of damage, to take the proper actions.

Shortcomings in quantity and quality may be claimed in written form, within 8 days from the receipt of the goods.

If the claim is prompt and justified, Buyers have exclusively entitlement to replacement of the products.

Abatements as well as making good of direct or indirect loss shall not be possible.

4. PAYMENTS

If the customer defaults on the payment of an invoice or an installment, any and all other outstanding invoice amounts or installments shall immediately become due and payable. Consumers shall pay interest on the money debt during the time of default of € 25,00 plus a 7 points above the base rate. As far as Business Enterprises are concerned, we reserve the right to prove and claim a higher damage caused by the delay in payment.

In these cases, we will be unable to accept and execute any further orders until the settlement has been received.

5. TECHNICAL DATA

We reserve ourselves the right to modify the technical data stated, at any time and without notice.

On request, we will give assistance to the customers for the best use of the products, on the basis of available experience.

6. CONTROVERSIES

In case of lawsuits the competent court will be the one in Treviso.

7. PRIVACY

Our privacy policy updated in accordance with articles 13-14 of EU Regulations 2016/679 is available on our website www.cmngroup.eu, section "Conditions and Privacy".



PVC PROFILES FOR LIGHTBOXES





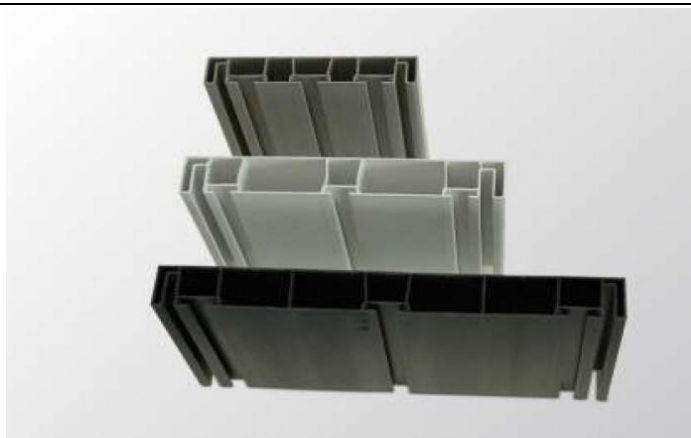

SYSTEM 4

Profiles and accessories suitable for making lightboxes with low equipment.
 Easy to cut and assemble.
 Front and bottom thickness max. 4 mm.

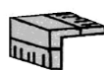

Code	Description			€/m	€/Pcs.
	Type	Material	Colour		
FPR90B	Profile 90 - 4 m	PVC	White	€ 6,60	€ 26,39
FPR90N	Profile 90 - 4 m	PVC	Black	€ 6,60	€ 26,39
FPR130B	Profile 130 - 4 m	PVC	White	€ 9,03	€ 36,10
FPR130N	Profile 130 - 4 m	PVC	Black	€ 9,03	€ 36,10
FPR180B	Profile 180 - 4 m	PVC	White	€ 12,94	€ 51,78
FPR180N	Profile 180 - 4 m	PVC	Black	€ 12,94	€ 51,78
FPR25	Angular 25x25x1,5 - 4 m	PVC	White	€ 2,51	€ 10,05
FPR25N	Angular 25x25x1,5 - 4 m	PVC	Black	€ 2,51	€ 10,05
FTUBETTO	Square tube 15x15x1,5 - 4 m	Aluminium	Mill Finish	€ 5,96	€ 23,85

Cutting on demand

Accessories Code	Description	€/Pack.	Image
FANG90X	90 mm PVC connection angle white/black	€ 1,27	
FANG130X	130 mm PVC connection angle white/black	€ 1,49	
FANG180B	190 mm PVC connection angle white/black	€ 1,68	
FCUR130B	130 mm PVC connection bend white/black	€ 2,01	
FSQ	Zinc plated steel L bracket 25x45	€ 0,69	
FVIT15C	500 pcs. package of 15 mm 6 MA screws	see page 4.12	
FDADOC	500 pcs. package of 6 MA hexagonal nuts	€ 35,52	

Grey PVC profiles and accessories on demand



PVC PROFILES FOR LIGHTBOXES

SYSTEM L

Profiles and accessories with fitting edge to reduce the use of anti-aesthetic screws.
 Front and bottom thickness max. 4 mm.

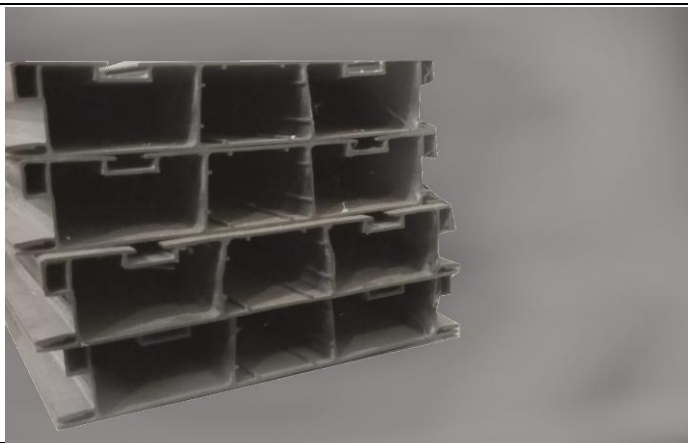

Code	Description			€/m	€/Pcs.
	Type	Material	Colour		
FPRL150B	Profile 143 - 4 m	PVC	White	€ 11,73	€ 46,92
FPRL150N	Profile 143 - 4 m	PVC	Black	€ 11,73	€ 46,92
FPR823B	Clamping angular 8x23 - 4 m	PVC	White	€ 2,12	€ 8,50
FPR823N	Clamping angular 8x23 - 4 m	PVC	Black	€ 2,12	€ 8,50

Cutting on demand

Accessories Code	Description	€/Pack.	Image
FANL150X	Connection angle white/black	€ 1,08	

PVC PROFILES FOR LIGHTBOXES

MARTINA PROFILES

ON DEMAND

Particularly robust PVC profiles, resistant to acids and salts, suitable for making lightboxes near the sea.

They do not require external screws or bolts.







Easy to cut, assemble and install.

Front and bottom thickness max. 4 mm.



Code	Description			€/m	€/Pcs.
	Type	Material	Colour		
M1100042	Main profile 11 cm - 4 m	PVC	White	€ 7,26	€ 29,04
M1500040	Main profile 15 cm - 4 m	PVC	White	€ 11,26	€ 45,03
M1500041	Main profile 15 cm - 4 m	PVC	Grey	€ 11,26	€ 45,03
M1900040	Main profile 19 cm - 4 m	PVC	White	€ 14,02	€ 56,07
M1900041	Main profile 19 cm - 4 m	PVC	Grey	€ 14,02	€ 56,07
M0001040	Clamping angular - 4 m	PVC	White	€ 1,58	€ 6,32
M0003040	Clamping angular - 4 m	PVC	Grey	€ 1,58	€ 6,32

Other colours on demand

Accessories Code	Description	€/Pack.	Image
M1000000	Assembly corner for 11 cm profile	€ 0,74	
M0000000	Assembly corner for 15/19 cm profiles	€ 2,60	
MCORSOIO	Slider	€ 0,54	
MPIOLO	Peg	€ 0,50	
M0000002	Bracket for 11 cm profile	€ 4,90	
M0000001	Bracket for 15/19 cm profiles	€ 4,90	

PROFILES 80

Profile for single or double sided lightboxes with rigid front and back panels up to 4 mm thick.

The 20x20 mm L profile is fixed with screws onto the 73 mm profile to obtain a side that could be open to let the front panel slide out.

To ease mounting and internal inspection it is necessary that at least one side of the lightbox is made with these profiles, the other sides are made with the 80 mm profile.

The FSQ corners are used both to join mitred corners and to mount reinforcements made with 15x15 mm square tube.

The sides of front and back panels must be 7 mm shorter than the overall dimensions of the lightbox to accommodate thermal expansion.





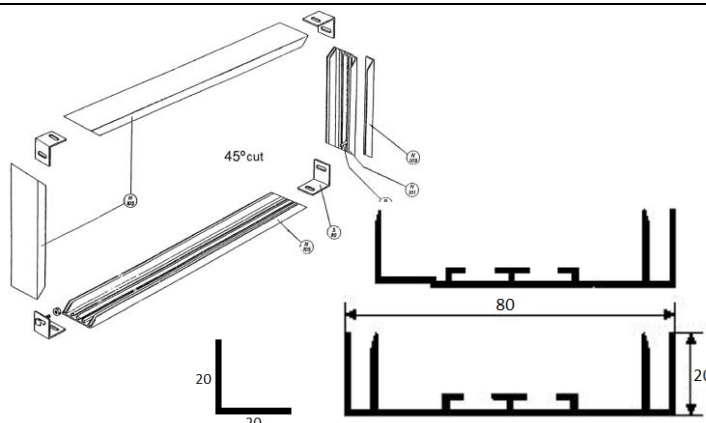



For NEON lighting see Ch. 5 (NEON lighting).

For modules and power supplies see Ch. 6 (LED lighting).



Code	Description			€/m	€/Pcs.
	Type	Material	Colour		
OP073101A	Profile 73 N101 - 6 m	Aluminium	Anodized Silver	€ 21,08	€ 126,48
OP080105A	Profile 80 N105 - 6 m	Aluminium	Anodized Silver	€ 21,35	€ 128,10
OP022109A	Angular 20x20x1,5 - 6 m	Aluminium	Anodized Silver	€ 6,65	€ 39,90
OP023112A	Angular 20x30x2 - 6 m	Aluminium	Anodized Silver	€ 10,20	€ 61,20
OP015111A	Square tube 15x15x1,5 - 6 m	Aluminium	Mill Finish	€ 6,13	€ 36,75

Cutting, coloured painting/anodizing and curved angulars on demand

Accessories Code	Description	€/Pack.	Image
OS080A	Aluminium bracket	€ 2,75	
OA080A	Aluminium connection angle	€ 3,00	
OC080A	Aluminium connection bend	€ 3,60	
OT119	Cap for connection angles	€ 0,68	
OTC112	Cap for connection bend	€ 1,05	
OBB130C	500 pcs. package of 12 mm 6 MA screws with nuts	€ 82,18	
OBB140C	500 pcs. package of 40 mm 6 MA screws with nuts	€ 137,28	
OPIF210	Bracket for double sided lightboxes	€ 31,07	

PROFILES 120

Profile for single or double sided lightboxes with rigid front and back panels up to 4 mm thick.

The 20x20 mm L profile is fixed with screws onto the 113 mm profile to obtain a side that could be open to let the front panel slide out.

To ease mounting and internal inspection it is necessary that at least one side of the lightbox is made with these profiles, the other sides are made with the 120 mm profile. The FSQ corners are used both to join mitred corners and to mount reinforcements made with 15x15 mm square tube.

The sides of front and back panels must be 7 mm shorter than the overall dimensions of the lightbox to accommodate thermal expansion.





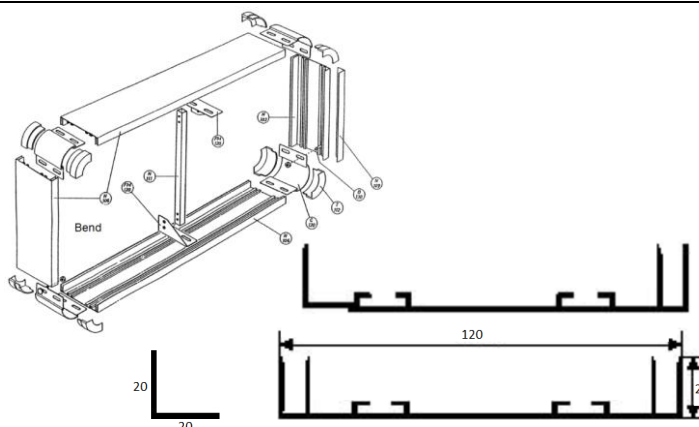



For NEON lighting see Ch. 5 (NEON lighting).

For modules and power supplies see Ch. 6 (LED lighting).



Code	Description			€/m	€/Pcs.
	Type	Material	Colour		
OP113102A	Profile 113 N102 - 6 m	Aluminium	Anodized Silver	€ 23,10	€ 138,60
OP120106A	Profile 120 N106 - 6 m	Aluminium	Anodized Silver	€ 24,85	€ 149,10
OPO22109A	Angular 20x20x1,5 - 6 m	Aluminium	Anodized Silver	€ 6,65	€ 39,90
OPO23112A	Angular 20x30x2 - 6 m	Aluminium	Anodized Silver	€ 10,20	€ 61,20
OP015111A	Square tube 15x15x1,5 - 6 m	Aluminium	Mill Finish	€ 6,13	€ 36,78

Cutting, coloured painting/anodizing and curved angulars on demand

Accessories Code	Description	€/Pack.	Image
OS120A	Aluminium bracket	€ 3,00	
OFM120A	Aluminium reinforcing bracket right or left	€ 3,05	
OA120A	Aluminium connection angle	€ 3,70	
OC120A	Aluminium connection bend	€ 4,43	
OT119	Cap for connection angles	€ 0,68	
OTC112	Cap for connection bend	€ 1,05	
OBB130C	500 pcs. package of 12 mm 6 MA screws with nuts	€ 82,18	
OBB140C	500 pcs. package of 40 mm 6 MA screws with nuts	€ 137,28	
OPIF210	Bracket for double sided lightboxes	€ 31,07	

PROFILES 150

Profile for single or double sided lightboxes with rigid front and back panels up to 4 mm thick.

The 20x20 mm L profile is fixed with screws onto the 143 mm profile to obtain a side that could be open to let the front panel slide out.

To ease mounting and internal inspection it is necessary that at least one side of the lightbox is made with these profiles, the other sides are made with the 150 mm profile. The FSQ corners are used both to join mitred corners and to mount reinforcements made with 15x15 mm square tube.

The sides of front and back panels must be 7 mm shorter than the overall dimensions of the lightbox to accommodate thermal expansion.





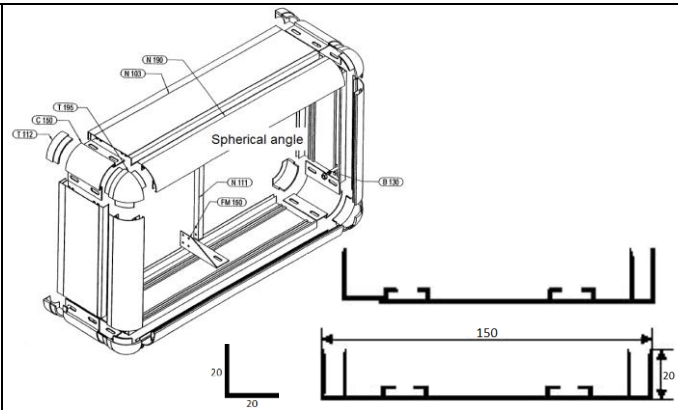





For NEON lighting see Ch. 5 (NEON lighting).

For modules and power supplies see Ch. 6 (LED lighting).



Code	Description			€/m	€/Pcs.
	Type	Material	Colour		
OP143103A	Profile 143 N103 - 6 m	Aluminium	Anodized Silver	€ 30,15	€ 180,90
OP150107A	Profile 150 N107 - 6 m	Aluminium	Anodized Silver	€ 31,45	€ 188,70
OP022109A	Angular 20x20x1,5 - 6 m	Aluminium	Anodized Silver	€ 6,65	€ 39,90
OP023112A	Angular 20x30x2 - 6 m	Aluminium	Anodized Silver	€ 10,20	€ 61,20
OP015111A	Square tube 15x15x1,5 - 6 m	Aluminium	Mill Finish	€ 6,13	€ 36,75

Reinforcing profile 100 mm length
Cutting coloured painting/anodizing and curved angulars on demand

Accessories Code	Description	€/Pack.	Image
OS150A	Aluminium bracket	€ 3,18	
OFM150A	Aluminium reinforcing bracket right or left	€ 3,43	
OFR150A	Aluminium reinforcing bracket for double sided lightboxes	€ 7,35	
OA150A	Aluminium connection angle	€ 4,33	
OC150A	Aluminium connection bend	€ 5,60	
OCF150A	Aluminium connection bend with hole	€ 9,03	
OT119	Cap for connection angles	€ 0,68	
OTC112	Cap for connection bend	€ 1,05	
OBB130C	500 pcs. package of 12 mm 6 MA screws with nuts	€ 82,18	
OBB140C	500 pcs. package of 40 mm 6 MA screws with nuts	€ 137,28	
OPIF210	Bracket for double sided lightboxes	€ 31,07	

PROFILES 170

Profile for single or double sided lightboxes with rigid front and back panels up to 4 mm thick.

Two 20x20 mm L profile are fixed with screws onto the 154 mm profile to obtain a side that could be open to let the front panel slide out.

To ease mounting and internal inspection it is necessary that at least one side of the lightbox is made with these profiles, the other sides are made with the 170 mm profile. The FSQ corners are used both to join mitred corners and to mount reinforcements made with 15x15 mm square tube.

The sides of front and back panels must be 7 mm shorter than the overall dimensions of the lightbox to accommodate thermal expansion.





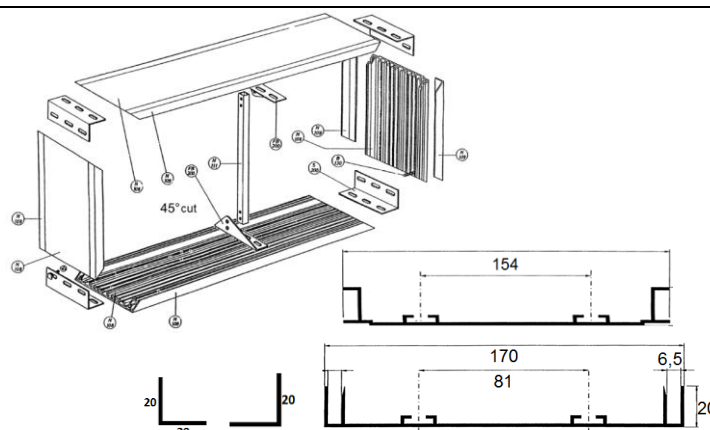





For NEON lighting see Ch. 5 (NEON lighting).

For modules and power supplies see Ch. 6 (LED lighting).



Code	Description			€/m	€/Pcs.
	Type	Material	Colour		
OP170104A	Profile 154 N104 - 6 m	Aluminium	Anodized Silver	€ 29,13	€ 174,75
OP170174A	Profile 170 N174 - 6 m	Aluminium	Anodized Silver	€ 35,53	€ 213,15
OPO22109A	Angular 20x20x1,5 - 6 m	Aluminium	Anodized Silver	€ 6,65	€ 39,90
OPO23112A	Angular 20x30x2 - 6 m	Aluminium	Anodized Silver	€ 10,20	€ 61,20
OP015111A	Square tube 15x15x1,5 - 6 m	Aluminium	Mill Finish	€ 6,13	€ 36,75

Cutting, coloured painting/anodizing and curved angulars on demand

Accessories Code	Description	€/Pack.	Image
OS170A	Aluminium bracket.	€ 3,85	
OFM170A	Aluminium reinforcing bracket right or left	€ 3,70	
OA170A	Aluminium connection angle	€ 5,95	
OC170A	Aluminium connection bend	€ 7,38	
OCF170A	Aluminium connection bend with hole	€ 10,23	
OT119	Cap for connection angles	€ 0,68	
OTC112	Cap for connection bend	€ 1,05	
OBB130C	500 pcs. package of 12 mm 6 MA screws with nuts	€ 82,18	
OBB140C	500 pcs. package of 40 mm 6 MA screws with nuts	€ 137,28	
OPIF210	Bracket for double sided lightboxes	€ 31,07	

PROFILES 200

Profile for single or double sided lightboxes with rigid front and back panels up to 4 mm thick.

Two 20x20 mm L profile are fixed with screws onto the 183 mm profile to obtain a side that could be open to let the front panel slide out.

To ease mounting and internal inspection it is necessary that at least one side of the lightbox is made with these profiles, the other sided are made with the 200 mm profile. The FSQ corners are used both to join mitred corners and to mount reinforcements made with 15x15 mm square tube.

The sides of front and back panels must be 7 mm shorter than the overall dimensions of the lightbox to accommodate thermal expansion.

For NEON lighting see Ch. 5 (NEON lighting).

For modules and power supplies see Ch. 6 (LED lighting).

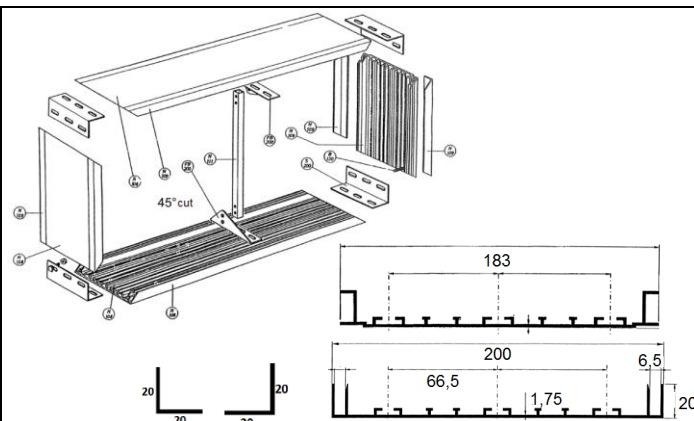

Code	Description			€/m	€/Pcs.
	Type	Material	Colour		
OP200180A	Profile 183 N180 - 6 m	Aluminium	Anodized Silver	€ 42,58	€ 255,45
OP200124A	Profile 200 N124 - 6 m	Aluminium	Anodized Silver	€ 45,25	€ 271,50
OP022109A	Angular 20x20x1,5 - 6 m	Aluminium	Anodized Silver	€ 6,65	€ 39,90
OP023112A	Angular 20x30x2 - 6 m	Aluminium	Anodized Silver	€ 10,20	€ 61,20
OP015111A	Square tube 15x15x1,5 - 6 m	Aluminium	Mill Finish	€ 6,13	€ 36,75

Reinforcing profile 100 mm length
Cutting coloured painting/anodizing and curved angulars on demand

Accessories Code	Description	€/Pack.	Image
OS200A	Aluminium bracket	€ 4,55	
OFM200A	Aluminium reinforcing bracket right or left	€ 4,13	
OFR200A	Aluminium reinforcing bracket for double sided lightboxes	€ 7,88	
OA200A	Aluminium connection angle	€ 6,85	
OC200A	Aluminium connection bend	€ 8,75	
OCF200A	Aluminium connection bend with hole	€ 11,68	
OT119	Cap for connection angles	€ 0,68	
OTC112	Cap for connection bend	€ 1,05	
OBB130C	500 pcs. package of 12 mm 6 MA screws with nuts	€ 82,18	
OBB140C	500 pcs. package of 40 mm 6 MA screws with nuts	€ 137,28	
OPIF210	Bracket for double sided lightboxes	€ 31,07	

ALUMINIUM PROFILES FOR LIGHTBOXES

PROFILES 80

Extruded aluminium profile for light boxes.
 Ideal for small single-sided light boxes.
 Profile size 80 mm total complete with profile 73 + 20x20 corner piece.
 Use sheets with a maximum thickness of 4 mm.
 Internal brackets can be used for 45° profile cuts, or corner pieces or curves (with end caps) for 90° profile cuts.





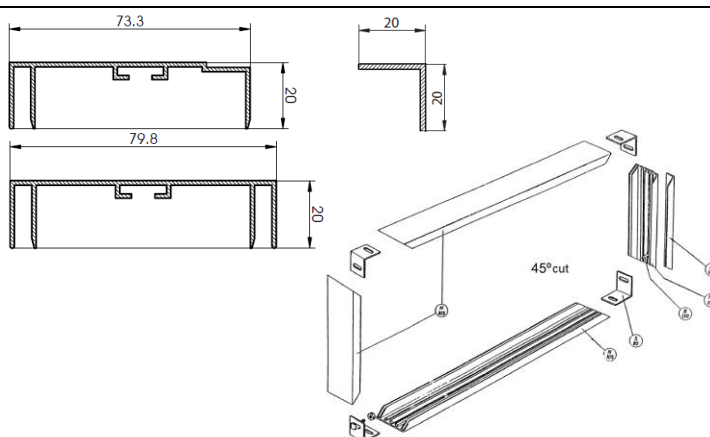

For NEON lighting systems, see Chapter 5 (NEON lighting).
 For LED modules and power supplies, see Chapter 6 (LED lighting).

Please note: to obtain the desired box dimensions when using FCUR curves or FANG corner pieces, it is necessary to reduce the length of the profiles by 100 mm (FCUR) and 40 mm (FANG).



Code	Description			€/m	€/Pcs.
	Type	Material	Colour		
FPRA736	Profile 73 - 6 m	Aluminium	Anodized Silver	€ 10,73	€ 64,35
FPRA806	Profile 80 - 6 m	Aluminium	Anodized Silver	€ 15,60	€ 93,60
FPRA206	Angular 20x20x1,5 - 6 m	Aluminium	Anodized Silver	€ 4,95	€ 29,70
FTUBETTO	Square tube 15x15x1,5 - 4 m	Aluminium	Mill Finish	€ 5,46	€ 21,86

Customised cutting and anodised or painted profiles in other colours available on request.

Accessories Code	Description	€/Pack.	Image
FSQ	Zinc plated steel L bracket 25x45	€ 0,75	
FANG80	Aluminium connection angle (NB - Subtract 40 mm from the length of the profile)	€ 8,36	
FCUR80	Aluminium connection bend (NB - Subtract 100 mm from the length of the profile)	€ 11,95	
FTAP	Cap for connection angles	€ 0,63	
FTAPC	Cap for connection bend	€ 2,54	
FVIT15C	500 pcs. package of 15 mm 6 MA screws	€ 82,91	
FDADOC	500 pcs. package of 6 MA hexagonal nuts	€ 35,27	

ALUMINIUM PROFILES FOR LIGHTBOXES



PROFILES 120

Extruded aluminium profile for light boxes.
 Ideal for small and medium-sized single-sided light boxes.
 Profile size 120 mm total complete with profile 113 + 20x20 corner piece.
 Use sheets with a maximum thickness of 4 mm.
 Internal brackets can be used for 45° profile cuts, or corner brackets or curves (with end caps) for 90° profile cuts.
 We recommend reinforcing the structure using an internal support tube.





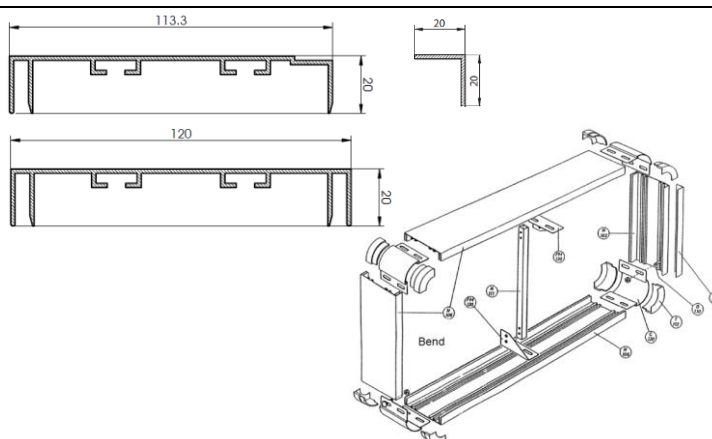

For NEON lighting systems, see Chapter 5 (NEON lighting).
 For LED modules and power supplies, see Chapter 6 (LED lighting).

Please note: to obtain the desired box dimensions when using FCUR curves or FANG corner pieces, it is necessary to reduce the length of the profiles by 100 mm (FCUR) and 40 mm (FANG).

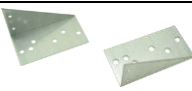

Code	Description			€/m	€/Pcs.
	Type	Material	Colour		
FPRA1136	Profile 113 - 6 m	Aluminium	Anodized Silver	€ 17,90	€ 107,40
FPRA1206	Profile 120 - 6 m	Aluminium	Anodized Silver	€ 19,53	€ 117,15
FPRA206	Angular 20x20x1,5 - 6 m	Aluminium	Anodized Silver	€ 4,95	€ 29,70
FTUBETTO	Square tube 15x15x1,5 - 4 m	Aluminium	Mill Finish	€ 5,46	€ 21,86

Customised cutting and anodised or painted profiles in other colours available on request.

Accessories Code	Description	€/Pack.	Image
FSQ120	Zinc plated steel L bracket	€ 2,54	
FANG120	Aluminium connection angle (NB - Subtract 40 mm from the length of the profile)	€ 9,25	
FCUR120	Aluminium connection bend (NB - Subtract 100 mm from the length of the profile)	€ 13,44	
FSF120	Zinc plated steel right or left	€ 2,87	
FTAP	Cap for connection angles	€ 0,63	
FTAPC	Cap for connection bend	€ 2,54	
FVIT15C	500 pcs. package of 6 MA screws	€ 82,91	
FDADOC	500 pcs. package of 6 MA hexagonal nuts	€ 35,52	

ALUMINIUM PROFILES FOR LIGHTBOXES



PROFILES 150

Extruded aluminium profile for light boxes.
 Ideal for medium and large single-sided and double-sided light boxes.
 Profile size 150 mm total complete with profile 143 + 20x20 corner piece.
 Use sheets with a maximum thickness of 4 mm.
 Internal brackets can be used for 45° profile cuts, or corner brackets or curves (with end caps) for 90° profile cuts.
 We recommend reinforcing the structure using an internal support tube.







For NEON lighting systems, see Chapter 5 (NEON lighting).
 For LED modules and power supplies, see Chapter 6 (LED lighting).

Please note: to obtain the desired box dimensions when using FCUR curves or FANG corner pieces, it is necessary to reduce the length of the profiles by 100 mm (FCUR) and 40 mm (FANG).

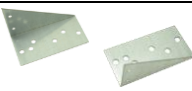

Code	Description			€/m	€/Pcs.
	Type	Material	Colour		
FPRA1436	Profile 143 - 6 m	Aluminium	Anodized Silver	€ 19,78	€ 118,65
FPRA1506	Profile 150 - 6 m	Aluminium	Anodized Silver	€ 21,90	€ 131,40
FPRA206	Angular 20x20x1,5 - 6 m	Aluminium	Anodized Silver	€ 4,95	€ 29,70
FTUBETTO	Square tube 15x15x1,5 - 4 m	Aluminium	Mill Finish	€ 5,46	€ 21,86

Customised cutting and anodised or painted profiles in other colours available on request.

Accessories Code	Description	€/Pack.	Image
FSQ150	Zinc plated steel L bracket	€ 2,87	
FANG150	Aluminium connection angle (NB - Subtract 40 mm from the length of the profile)	€ 10,18	
FCUR150	Aluminium connection bend (NB - Subtract 100 mm from the length of the profile)	€ 14,93	
FSF150	Zinc plated steel right or left	€ 3,12	
FTAP	Cap for connection angles	€ 0,63	
FTAPC	Cap for connection bend	€ 2,54	
FVIT15C	500 pcs. package of 6 MA screws	€ 82,91	
FDADOC	500 pcs. package of 6 MA hexagonal nuts	€ 35,52	

ALUMINIUM PROFILES FOR LIGHTBOXES



PROFILES 163

Extruded aluminium profile for light boxes.
 Ideal for medium and large single-sided and double-sided light boxes.
 Profile size 170 mm total complete with profile 163 + 20x20 corner piece.
 Use sheets with a maximum thickness of 4 mm.
 Internal brackets can be used for 45° profile cuts, or corner brackets or curves (with end caps) for 90° profile cuts.
 We recommend reinforcing the structure using an internal support tube.





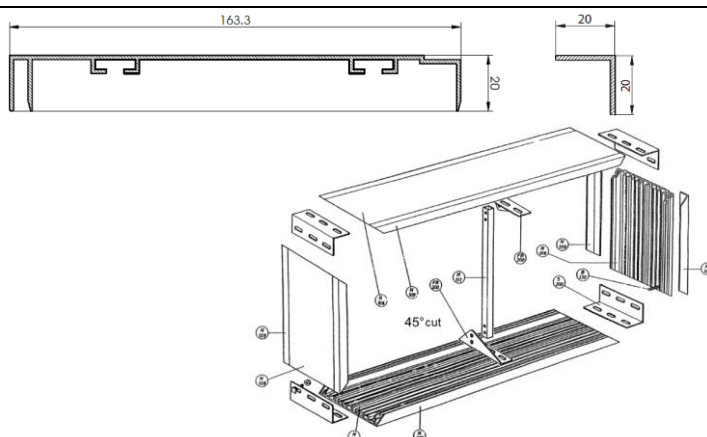

For NEON lighting systems, see Chapter 5 (NEON lighting).
 For LED modules and power supplies, see Chapter 6 (LED lighting).

Please note: to obtain the desired box dimensions when using FCUR curves or FANG corner pieces, it is necessary to reduce the length of the profiles by 100 mm (FCUR) and 40 mm (FANG).



Code	Description			€/m	€/Pcs.
	Type	Material	Colour		
FPRA1636	Profile 163 - 6 m	Aluminium	Anodized Silver	€ 19,33	€ 115,95
FPRA206	Angular 20x20x1,5 - 6 m	Aluminium	Anodized Silver	€ 4,95	€ 29,70
FTUBETTO	Square tube 15x15x1,5 - 4 m	Aluminium	Mill Finish	€ 5,46	€ 21,86

Customised cutting and anodised or painted profiles in other colours available on request.

Accessories Code	Description	€/Pack.	Image
FSQ150	Zinc plated steel L bracket	€ 2,87	
FANG170	Aluminium connection angle (NB - Subtract 40 mm from the length of the profile)	€ 10,76	
FCUR170	Aluminium connection bend (NB - Subtract 100 mm from the length of the profile)	€ 16,12	
FSF170	Zinc plated steel right or left	€ 3,12	
FTAP	Cap for connection angles	€ 0,63	
FTAPC	Cap for connection bend	€ 2,54	
FVIT15C	500 pcs. package of 6 MA screws	€ 82,91	
FDADOC	500 pcs. package of 6 MA hexagonal nuts	€ 35,52	

ALUMINIUM PROFILES FOR LIGHTBOXES



PROFILES 186

Profile for single or double sided lightboxes with rigid front and back panels up to 4 mm thick.

Two 25x25 mm L profile are fixed with screws onto the 186 mm profile to obtain a side that could be open to let the front panel slide out.

To ease mounting and internal inspection it is necessary that at least one side of the lightbox is made with these profiles, the other sides are made with the 200 mm profile. The FSQ corners are used both to join mitred corners and to mount reinforcements made with 15x15 mm square tube.

The sides of front and back panels must be 7 mm shorter than the overall dimensions of the lightbox to accommodate thermal expansion.

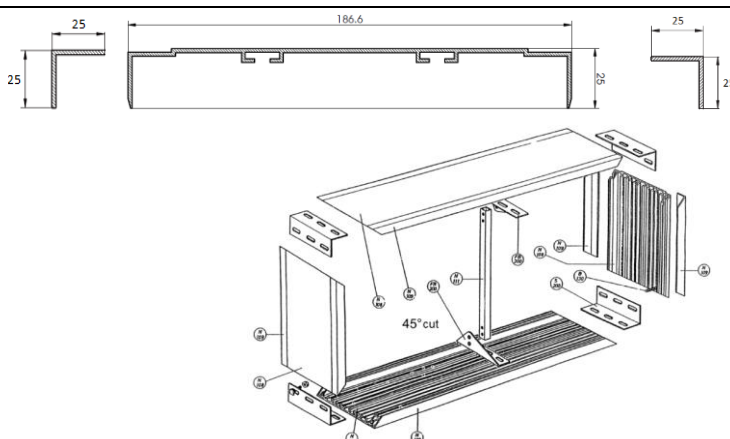

For NEON lighting see Ch. 5 (NEON lighting).

For modules and power supplies see Ch. 6 (LED lighting).



Code	Description			€/m	€/Pcs.
	Type	Material	Colour		
FPRA1866*	Profile 186 - 6 m	Aluminium	Anodized Silver	€ 30,63	€ 183,75
FPRA256	Angular 25x25x1,5 - 6 m	Aluminium	Anodized Silver	€ 5,73	€ 34,38
FTUBETTO	Square tube 15x15x1,5 - 4 m	Aluminium	Mill Finish	€ 5,46	€ 21,86

Customised cutting and anodised or painted profiles in other colours available on request.
 * On this model we don't make any 45° cut

Accessories Code	Description	€/Pack.	Image
FSQ150	Zinc plated steel L bracket	€ 2,87	
FVIT15C	500 pcs. package of 6 MA screws	€ 82,91	
FDADOC	500 pcs. package of 6 MA hexagonal nuts	€ 35,52	

PROFILES FOR SINGLE SIDE TEXTILE LIGHTBOXES





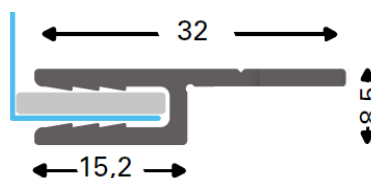

T-FLEX® 9/1 RETROFIT

Aluminium profile for single side frames with keder-edged tensioned fabrics.
 To be fixed on pre-existing wood, metal or wall structures.
 Size is limited only by the support structure.
 No corner connectors are needed, the profile is screwed or riveted to the desired part.

For LED modules and power supplies see Ch. 6 (LED lighting).



Code	Description			€/m	€/Pcs.
	Type	Material	Colour		
ED109PF010	Profile T-Flex 9/1 Single - 6,1 m	Aluminium	Anodized Silver	€ 7,22	€ 44,04
Cutting and coloured painting/anodizing on demand					

Accessories Code	Description	€/Pack.	Image
ED100PF010	3x14 transparent blue PVC flat keder 200 m reel	€ 79,38	
ED100PF030	3x14 transparent blue PVC flat keder 200 m reel	€ 79,38	
ED100PF020	7x13 grey PVC hammer keder 100 m reel	€ 207,90	
EOMFNASTRO	2,8x13,5 transparent PVC flat keder 100 m reel	€ 91,80	

PROFILES FOR SINGLE SIDE TEXTILE LIGHTBOXES



ECOPLUS SIMPLEX

Aluminium profile for single side non-illuminated frames with keder-edged tensioned fabrics.
 Suitable for wall mounted, small-to-medium format frames.
 Corner connectors come complete with screws.



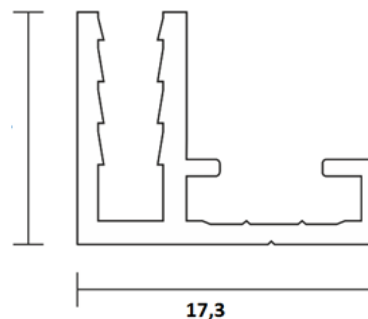



16,2



17,3

Code	Description			€/m	€/Pcs.
	Type	Material	Colour		
EEPLUS046	Profile Simplex Single - 6,1 m	Aluminium	Anodized Silver	€ 4,76	€ 29,04
EEPLUS041	Profile Simplex Single - 3,05 m	Aluminium	Anodized Silver	€ 4,76	€ 14,52

Cutting and coloured painting/anodizing on demand

Accessories Code	Description	€/Pack.	Image
EOSNCON25F	10 pcs. package of lateral L connectors	€ 6,72	
EEPLUSCONLS	Linear connector	€ 1,90	
ED100PF010	3x14 transparent blue PVC flat keder 200 m reel	€ 79,38	
ED100PF030	3x14 transparent blue PVC flat keder 200 m reel	€ 79,38	
ED100PF020	7x13 grey PVC hammer keder 100 m reel	€ 207,90	
EOMFNASTRO	2,8x13,5 transparent PVC flat keder 100 m reel	€ 91,80	

PROFILES FOR SINGLE SIDE TEXTILE LIGHTBOXES

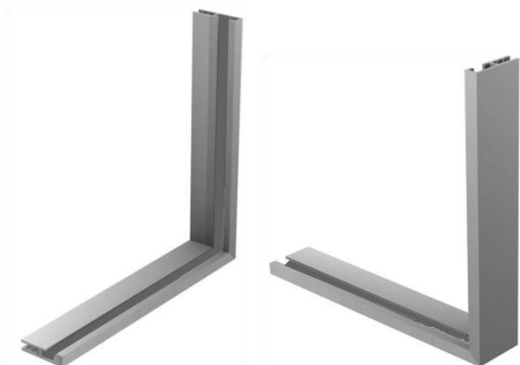

ECOPLUS ACE

Aluminium profile for single side non-illuminated frames with keder-edged tensioned fabrics.

Suitable for wall mounted small-to-medium format frames, could also be mounted on the edge of niches in walls and furnitures.

The metal corner connectors are available also in a version complete with plate for mounting.





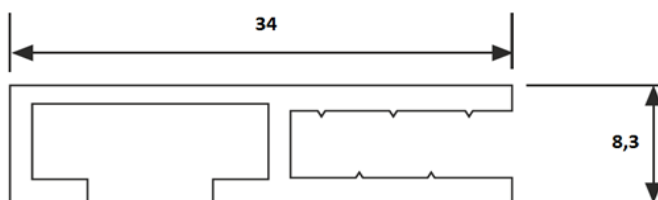

Corner connectors come complete with screws.

For LED modules and power supplies see Ch. 6 (LED lighting).



Code	Description			€/m	€/Pcs.
	Type	Material	Colour		
EOMFBPROF6	Profile Ace Single - 6,1 m	Aluminium	Anodized Silver	€ 7,25	€ 44,20
EOMFBPROF	Profile Ace Single - 3,05 m	Aluminium	Anodized Silver	€ 7,25	€ 22,10

Cutting and coloured painting/anodizing on demand

Accessories Code	Description	€/Pack.	Image
EOMFCONQUA	10 pcs. package of square angular connectors for 45° cut	€ 29,76	
EEPLUSCON100	10 pcs. package of internal L connectors	€ 27,70	
ED100PF010	3x14 transparent blue PVC flat keder 200 m reel	€ 79,38	
ED100PF030	3x14 transparent blue PVC flat keder 200 m reel	€ 79,38	
ED100PF020	7x13 grey PVC hammer keder 100 m reel	€ 207,90	
EOMFNASTRO	2,8x13,5 transparent PVC flat keder 100 m reel	€ 91,80	

PROFILES FOR SINGLE SIDE TEXTILE FRAMES AND STRUCTURES

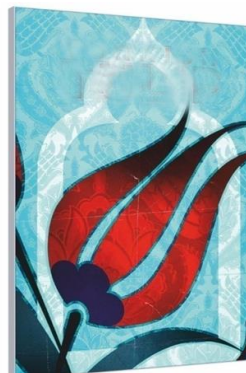

ECOPLUS DAME

Aluminium profile for single side non-illuminated frames with keder-edged tensioned fabrics.

Suitable for wall mounted, medium-to-large format frames.

In case of mitred 45° cut it can accommodate up to 3 metal connectors per corner, available also with plate for wall mounting.

Plastic corner connectors for 90° cut.

The use of reinforcement profiles is recommended for sides longer than 2 m





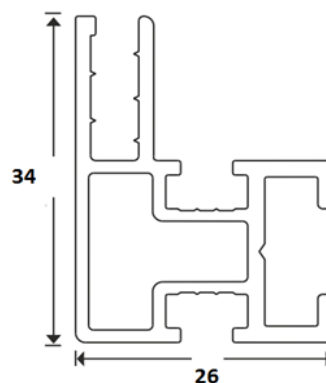





Corner connectors come complete with screws.

For LED modules and power supplies see Ch. 6 (LED lighting).



Code	Description			€/m	€/Pcs.
	Type	Material	Colour		
EOMFGPROF6	Profile Dame Single - 6,1 m	Aluminium	Anodized Silver	€ 11,50	€ 70,16
EOMFGPROF	Profile Dame Single - 3,05 m	Aluminium	Anodized Silver	€ 11,50	€ 35,08

Cutting and coloured painting/anodizing on demand

Accessories Code	Description	€/Pack.	Image
EOMFCONQUA	10 pcs. package of square angular connectors for 45° cut	€ 29,76	
EOSNCON25F	10 pcs. package of lateral L connectors	€ 6,72	
EEPLUSCON100	10 pcs. package of internal L connectors	€ 27,70	
EOMFGANG	10 pcs. package of external plastic square angular connectors	€ 12,80	
EOMFH	3,00 m of 45x16 H shaped support profiles	€ 33,30	
EOMFHCON	10 pcs. package of connectors for H profiles	€ 34,10	
ED100PF010	3x14 transparent blue PVC flat keder 200 m reel	€ 79,38	
ED100PF030	3x14 transparent blue PVC flat keder 200 m reel	€ 79,38	
ED100PF020	7x13 grey PVC hammer keder 100 m reel	€ 207,90	
EOMFNASTRO	2,8x13,5 transparent PVC flat keder 100 m reel	€ 91,80	

PROFILES FOR DOUBLE SIDE TEXTILE FRAMES AND STRUCTURES



ECOPLUS KING





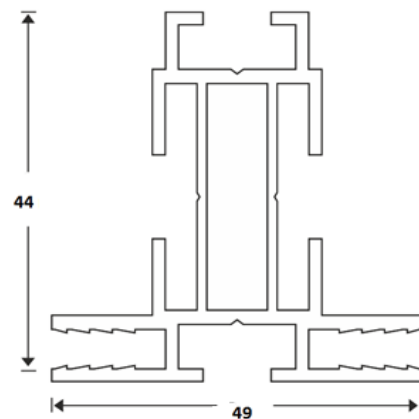





Aluminium profile for double side non-illuminated frames with keder-edged tensioned fabrics.
 Suitable for small-to-medium size hanging or self-standing structures with feet.
 In case of mitred 45° cut it can accommodate up to 3 metal connectors per corner.
 Plastic corner connectors for 90° cut.
 The use of reinforcement profiles is recommended for sides longer than 2 m
 Corner connectors come complete with screws.

For LED modules and power supplies see Ch. 6 (LED lighting).



Code	Description			€/m	€/Pcs.
	Type	Material	Colour		
EOMFOPROF6	Profile King Double - 6,1 m	Aluminium	Anodized Silver	€ 20,07	€ 122,44
EOMFOPROF	Profile King Double - 3,05 m	Aluminium	Anodized Silver	€ 20,07	€ 61,22

Cutting and coloured painting/anodizing on demand

Accessories Code	Description	€/Pack.	Image
EOMFCONCUN	8 pcs. package of lateral L connectors for 45° cut	€ 30,16	
EEPLUSCON100	10 pcs. package of internal L connectors	€ 27,70	
EOMFOANG	4 pcs. package of lateral L external plastic connectors	€ 12,80	
EOMFH	3,05 m of 45x16 H shaped support profiles	€ 33,30	
EOMFHCON	10 pcs. package of connectors for H profiles	€ 34,10	
EOMFOFF	Iron base 100x600 with connector	€ 49,60	
EOMFKIT	2 pcs. package of standard suspension kit	€ 21,24	
ED100PF010	3x14 transparent blue PVC flat keder 200 m reel	€ 79,38	
ED100PF020	7x13 grey PVC hammer keder 100 m reel	€ 207,90	
EOMFNASTRO	2,8x13,5 transparent PVC flat keder 100 m reel	€ 91,80	

PROFILES FOR DOUBLE SIDE TEXTILE FRAMES AND STRUCTURES



T-FLEX 46/2 BASIC

Aluminium profile for double side non-illuminated frames with keder-edged tensioned fabrics.

Suitable for small-to-medium size hanging or self-standing structures with feet.

In case of mitred 45° cut it can accommodate up to 2 metal connectors per corner.

Plastic corner connectors for 90° cut.







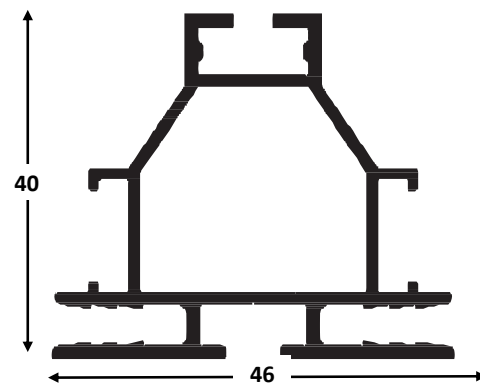



The use of reinforcement profiles is recommended for sides longer than 2 m

Corner connectors come complete with screws.

For LED modules and power supplies see Ch. 6 (LED lighting).



Code	Description			€/m	€/Pcs.
	Type	Material	Colour		
ED146PF010	Profilo T-Flex 46/2 - 6,1 m	Aluminium	Anodized Silver	€ 18,25	€ 111,33
Cutting and coloured painting/anodizing on demand					

Accessories Code	Description	€/pc.	Image
ED117PF016	Steel L-angle connector for T-Flex 17 and 46	€ 1,11	
ED146PF016	Straight connector 100 mm ²	€ 1,01	
ED196PF015	Foot B steel 400x60 RAL 9006	€ 34,59	
ED400PC015	Reinforcement profile anodised 6.10 m	€ 13,46	
ED146PF017	Connector for H-profiles	€ 3,17	
ED146PF018	Standard suspension kit pcs. 2	€ 17,24	
ED100PF010	PVC blue grommet 3x14 for fabric 200 m	€ 79,38	
ED100PF030	3x14 transparent blue PVC flat keder 200 m reel	€ 79,38	
ED100PF020	PVC grommet grey 7x13 seamless 100 m	€ 207,90	
EOMFNASTRO	Transparent PVC perimeter trim 2.8x13.5 for fabric 100 m	€ 91,80	

PROFILES FOR DOUBLE SIDE TEXTILE FRAMES AND STRUCTURES



ECOPLUS 80

Aluminium profile for double side non-illuminated frames with keder-edged tensioned fabrics.

Suitable for medium-to-large size hanging or self-standing structures with feet.

Mitred 45° cut is necessary.

It can accommodate up to 4 metal connectors per corner.

The use of reinforcement profiles is recommended for sides longer than 3 m





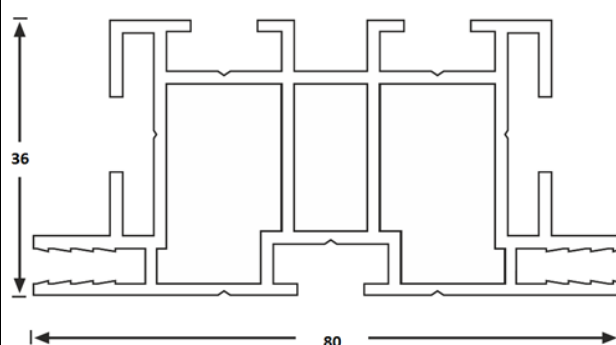





Corner connectors come complete with screws.

For LED modules and power supplies see Ch. 6 (LED lighting).



Code	Description			€/m	€/Pcs.
	Type	Material	Colour		
EEPLUS00806	Profile 80 Double - 6,1 m	Aluminium	Anodized Silver	€ 35,12	€ 214,24
EEPLUS0080	Profile 80 Double - 3,05 m	Aluminium	Anodized Silver	€ 35,12	€ 107,12

Cutting and coloured painting/anodizing on demand

Accessories Code	Description	€/Pack.	Image
EOMFCONCUN	8 pcs. package of lateral L connectors for 45° cut	€ 30,16	
EEPLUSCON100	10 pcs. package of internal L connectors	€ 27,70	
EOMFH	3,00 m of 45x16 H shaped support profiles	€ 33,30	
EOMFHCON	10 pcs. package of connectors for H profiles	€ 34,10	
EOMFOFF	Iron base 100x600 with connector	€ 49,60	
EOMFKIT	2 pcs. package of standard suspension kit	€ 21,24	
ED100PF010	3x14 transparent blue PVC flat keder 200 m reel	€ 79,38	
ED100PF030	3x14 transparent blue PVC flat keder 200 m reel	€ 79,38	
ED100PF020	7x13 grey PVC hammer keder 100 m reel	€ 207,90	
EOMFNASTRO	2,8x13,5 transparent PVC flat keder 100 m reel	€ 91,80	

PROFILES FOR SINGLE SIDE TEXTILE LIGHTBOXES



ECOPLUS 55

Aluminium profile for single side illuminated frames with keder-edged tensioned fabrics.

Suitable for thin, small-to medium format wall-mounted lightboxes.

Panels up to 3 mm thick can be screwed or riveted on the backside edge.





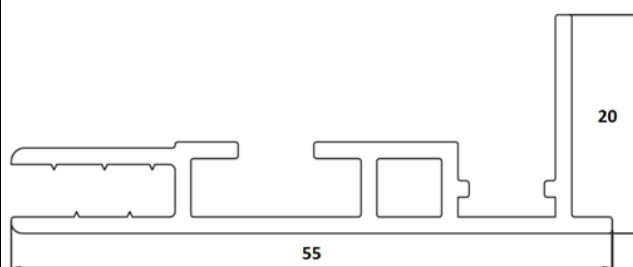

Corner connectors come complete with grub screws.

For LED modules and power supplies see Ch. 6 (LED lighting).



Code	Description			€/m	€/Pcs.
	Type	Material	Colour		
EEPLUS055	Profile 55 Single - 6,1 m	Aluminium	Anodized Silver	€ 11,72	€ 71,52
EEPLUS055B	Profile 55 Single - 6,1 m	Aluminium	Matt white	€ 12,89	€ 78,60
EEPLUS055N	Profile 55 Single - 6,1 m	Aluminium	Matt black	€ 12,89	€ 78,60

Cutting and coloured painting/anodizing on demand

Accessories Code	Description	€/Pack.	Image
EEPLUSCON100	10 pcs. package of internal L connectors	€ 27,70	
EEPLUSCONL	Linear connector	€ 2,50	
ED200AA000	Aluminium adhesive joining strip 45x2000	€ 12,98	
ED100PF010	3x14 transparent blue PVC flat keder 200 m reel	€ 79,38	
ED100PF030	3x14 transparent blue PVC flat keder 200 m reel	€ 79,38	
ED100PF020	7x13 grey PVC hammer keder 100 m reel	€ 207,90	
EOMFNASTRO	2,8x13,5 transparent PVC flat keder 100 m reel	€ 91,80	

PROFILES FOR SINGLE SIDE TEXTILE LIGHTBOXES

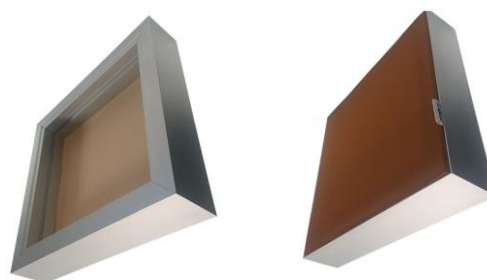
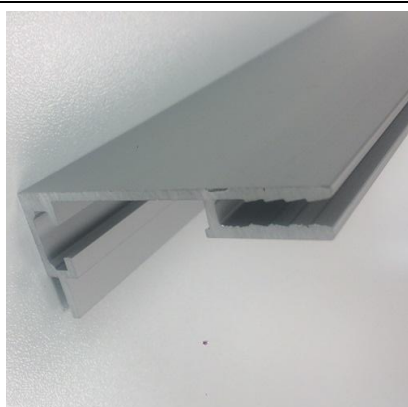

ECOPLUS MAXI

Aluminium profile for single side illuminated frames with keder-edged tensioned fabrics.

Suitable for thin, small-to medium format wall-mounted lightboxes.





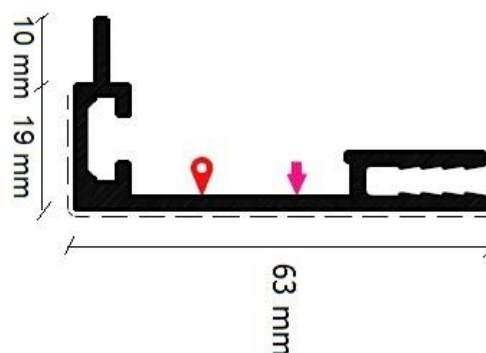

Panels up to 3 mm thick can be screwed or riveted on the backside edge.

Corner connectors come complete with grub screws.

For LED modules and power supplies see Ch. 6 (LED lighting).



Code	Description			€/m	€/Pcs.
	Type	Material	Colour		
EEPLUS063	Profile Maxi Single - 6,05 m	Aluminium	Anodized Silver	€ 14,56	€ 88,08
Cutting and coloured painting/anodizing on demand					

Accessories Code	Description	€/each	Image
EEPLUSCON	Corner connector for EcoPlus Maxi Corner	€ 1,41	
EEPLUSCONLM	Linear connector Conf. 10pcs	€ 9,79	
ED200AA000	Aluminium adhesive joining strip 45x2000	€ 11,91	
ED100PF010	3x14 transparent blue PVC flat keder 200 m reel	€ 79,38	
ED100PF030	3x14 transparent blue PVC flat keder 200 m reel	€ 79,38	
ED100PF020	7x13 grey PVC hammer keder 100 m reel	€ 207,90	
EOMFNASTRO	2,8x13,5 transparent PVC flat keder 100 m reel	€ 91,80	

PROFILES FOR SINGLE SIDE TEXTILE LIGHTBOXES



T-FLEX® 100

Aluminium profile for single side illuminated frames with keder-edged tensioned fabrics.

For medium-to-large wall-mounted or self-standing frames with feet.

The double channel for the keder allows the application of an inner white textile to improve diffusion and to hide the electrical parts during the printed textile changeover. Accepts 2 mm thick backside panels, it is suggested to fix them to the profile by means of the special backpanel support.





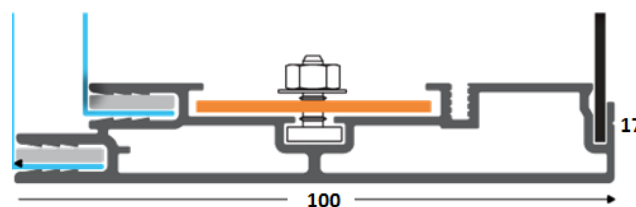



Corner connectors come complete with bolts and nuts.

For LED modules and power supplies see Ch. 6 (LED lighting).



Code	Description			€/m	€/Pcs.
	Type	Material	Colour		
ED110PF010	Profile T-Flex 100 Single - 6,1 m	Aluminium	Anodized Silver	€ 25,52	€ 155,64

Cutting and coloured painting/anodizing on demand

Accessories Code	Description	€/each	Image
ED110PF015	T-Flex 100 backpanel support 40 mm	€ 4,35	
ED110PF016	Corner connector FastFix	€ 3,36	
ED110PF017	Straight connector FastFix	€ 3,84	
ED196PF015	Foot B steel 400x60 RAL 9006	€ 34,59	
ED196PF016	Mounting plate for foot	€ 2,23	
LOJ06105	M5x20 screws, pack of 4	€ 2,40	
ED200AA000	Aluminium adhesive joining strip 45x2000	€ 12,98	
ED100PF010	3x14 transparent blue PVC flat keder 200 m reel	€ 79,38	
ED100PF030	3x14 transparent blue PVC flat keder 200 m reel	€ 79,38	
ED100PF020	7x13 grey PVC hammer keder 100 m reel	€ 207,90	
EOMFNASTRO	2,8x13,5 transparent PVC flat keder 100 m reel	€ 91,80	

PROFILES FOR SINGLE SIDE TEXTILE LIGHTBOXES

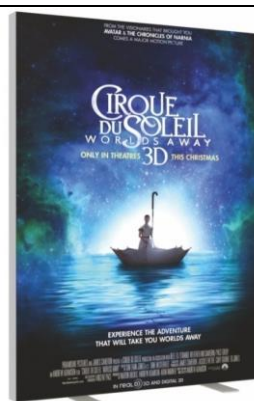

ECOPLUS 110

ON DEMAND

Profile for single side illuminated frames with keder-edged tensioned fabrics.

For medium-to-large wall-mounted or self-standing frames.

The double channel for the keder allows the application of an inner white textile to improve diffusion and to hide the electrical parts during the printed textile changeover. Accepts 2 mm thick backside panels, it is suggested to screw or rivet them to the backside edge of the profile.

The backside channel for the keder permits the use of a blackout textile as rear panel.

The use of reinforcement profiles is recommended for sides longer than 3 m





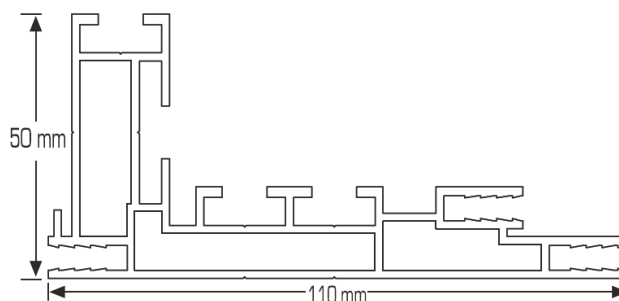





Corner connectors come complete with bolts and nuts.

For LED modules and power supplies see Ch. 6 (LED lighting).



Code	Description			€/m	€/Pcs.
	Type	Material	Colour		
EEPLUS01106	Profile 110 Single - 6,1 m	Aluminium	Anodized Silver	€ 37,70	€ 230,00
EEPLUS0110	Profile 110 Single - 3,05 m	Aluminium	Anodized Silver	€ 37,70	€ 115,00

Cutting and colored painting/anodizing on demand

Accessories Code	Description	€/Pack.	Image
EEPLUSCON100	10 pcs. package of internal L connectors	€ 27,70	
EOMFCONCUN	8 pcs. package of lateral L connectors for 45° cut	€ 30,16	
EOMFH	3,00 m of 45x16 H shaped support profiles	€ 33,30	
EOMFHCON	10 pcs. package of connectors for H profiles	€ 34,10	
EOMFOFF	Iron base 100x600 with connector (adaptable by drilling the profile)	€ 49,60	
ED200AA000	Aluminium adhesive joining strip 45x2000	€ 11,91	
ED100PF010	3x14 transparent blue PVC flat keder 200 m reel	€ 79,38	
ED100PF030	3x14 transparent blue PVC flat keder 200 m reel	€ 79,38	
ED100PF020	7x13 grey PVC hammer keder 100 m reel	€ 207,90	
EOMFNASTRO	2,8x13,5 transparent PVC flat keder 100 m reel	€ 91,80	

PROFILES FOR SINGLE SIDE TEXTILE LIGHTBOXES



T-FLEX® 150

Aluminium profile for single side illuminated frames with keder-edged tensioned fabrics.

For medium-to-large wall-mounted or self-standing frames with feet.

The double channel for the keder allows the application of an inner white textile to improve diffusion and to hide the electrical parts during the printed textile changeover. Accepts 2 mm thick backside panels, it is suggested to fix them to the profile by means of the special backpanel support.

The use of reinforcement profiles is recommended for sides longer than 3 m

Corner connectors come complete with bolts and nuts.

For LED modules and power supplies see Ch. 6 (LED lighting).

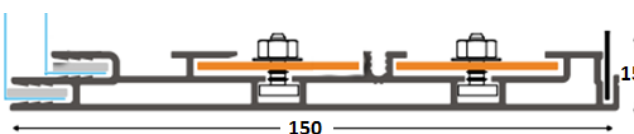

Code	Description			€/m	€/Pcs.
	Type	Material	Colour		
ED115PF010	Profile T-Flex 150 Single - 6,1 m	Aluminium	Anodized Silver	€ 35,13	€ 214,31

Cutting and coloured painting/anodizing on demand

Accessories Code	Description	€/each	Image
ED185PF015	T-Flex 150 backpanel support 40 mm	€ 4,26	
ED110PF016	Corner connector FastFix	€ 3,36	
ED110PF017	Straight connector FastFix	€ 3,84	
ED196PF015	Foot B steel 400x60 RAL 9006	€ 34,59	
ED196PF016	Mounting plate for foot	€ 2,23	
LOJ06105	M5x20 screws, pack of 4	€ 2,40	
ED115PF016	Assembly bracket for 40x20x2 reinforcements 35 mm	€ 3,97	
FTUB4020	Rectangular tube 40x20x2 mill 6 m	€ 50,25	
ED200AA000	Aluminium joining strip 45x2000	€ 12,98	
ED100PF030	3x14 transparent blue PVC flat keder 200 m reel	€ 79,38	
ED100PF010	3x14 transparent blue PVC flat keder 200 m reel	€ 79,38	
ED100PF020	7x13 grey PVC hammer keder 100 m reel	€ 207,90	
EOMFNASTRO	2,8x13,5 transparent PVC flat keder 100 m reel	€ 91,80	

PROFILES FOR DOUBLE SIDE TEXTILE LIGHTBOXES



T-FLEX® 96/2

Aluminium profile for double side illuminated frames with keder-edged tensioned fabrics.

For small-to-medium wall-mounted, suspended or self-standing frames with feet.
 The double channel for the keder allows the application of an inner white textile to improve diffusion and to hide the electrical parts during the printed textile changeover.
 The backpanel support of T-flex 100 can be used to fix T-flex 96/2 to walls.
 The use of reinforcement profiles is recommended for sides longer than 1,5 m
 Corner connectors come complete with bolts and nuts.

For LED modules and power supplies see Ch. 6 (LED lighting).

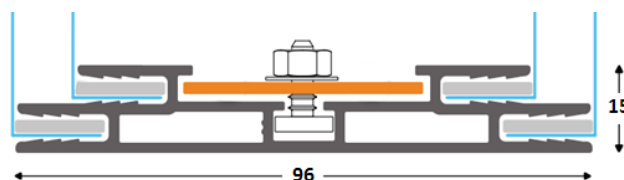

Code	Description			€/m	€/Pcs.
	Type	Material	Colour		
ED196PF010	Profile T-Flex 96/2 Double - 6,1 m	Aluminium	Anodized Silver	€ 24,78	€ 151,16

Cutting and coloured painting/anodizing on demand

Accessories Code	Description	€/each	Image
ED110PF015	T-Flex 100 backpanel support 40 mm (to be used for wall-mounting)	€ 4,35	
ED110PF016	Corner connector FastFix	€ 3,36	
ED110PF017	Straight connector FastFix	€ 3,84	
ED196PF015	Foot B steel 400x60 RAL 9006	€ 34,59	
ED185PF020	Support bracket 25 mm with holes incl. 2 x hammerhead-bolts/nuts, for 30x30x2 reinforcements	€ 3,99	
ED196PF016	T-Flex mounting plate foot	€ 2,23	
LOJ06105	M5x20 screws, pack of 4	€ 2,40	
ED196PF017	Reinforcement square tube 30x30x2 RAL 9016, 6 m	€ 10,61	
ED100PF010	3x14 transparent blue PVC flat keder 200 m reel	€ 79,38	
ED100PF030	3x14 transparent blue PVC flat keder 200 m reel	€ 79,38	
ED100PF020	7x13 grey PVC hammer keder 100 m reel	€ 207,90	
EOMFNASTRO	2,8x13,5 transparent PVC flat keder 100 m reel	€ 91,80	

PROFILES FOR DOUBLE SIDE TEXTILE LIGHTBOXES

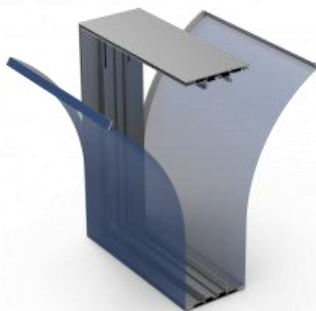

T-FLEX® 120/2

Aluminium profile for double side illuminated frames with keder-edged tensioned fabrics.
 For small-to-medium wall-mounted, suspended or self-standing frames with feet.
 The double channel for the keder allows the application of an inner white textile to improve diffusion and to hide the electrical parts during the printed textile changeover.
 The use of reinforcement profiles is recommended for sides longer than 1,5 m
 Corner connectors come complete with bolts and nuts.

For LED modules and power supplies see Ch. 6 (LED lighting).

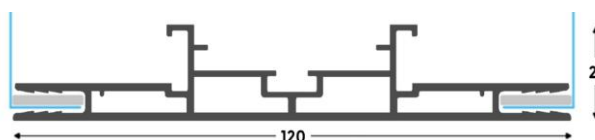

Code	Description			€/m	€/Pcs.
	Type	Material	Colour		
ED120PF010	Profile T-Flex 96/2 Double - 6,1 m	Aluminium	Anodized Silver	€ 27,41	€ 167,17
Cutting and coloured painting/anodizing on demand					

Accessories Code	Description	€/each	Image
ED117PF016	Steel L angle T-Flex17 connector	€ 1,11	
ED110PF016	Corner connector FastFix	€ 3,36	
ED110PF017	Straight connector FastFix	€ 3,84	
ED196PF015	Foot B steel 400x60 RAL 9006	€ 34,59	
ED196PF016	Mounting plate for foot	€ 2,23	
LOJ06106	M5x20 screws, pack of 4	€ 2,40	
ED185PF020	Support bracket 25 mm with holes incl. 2 x hammerhead-bolts/nuts, for 30x30x2 reinforcements	€ 3,99	
ED196PF017	Reinforcement square tube 30x30x2 RAL 9016, 6 m	€ 10,61	
ED100PF010	3x14 transparent blue PVC flat keder 200 m reel	€ 79,38	
ED100PF030	3x14 transparent blue PVC flat keder 200 m reel	€ 79,38	
ED100PF020	7x13 grey PVC hammer keder 100 m reel	€ 207,90	
EOMFNASTRO	2,8x13,5 transparent PVC flat keder 100 m reel	€ 91,80	

PROFILES FOR DOUBLE SIDE TEXTILE LIGHTBOXES









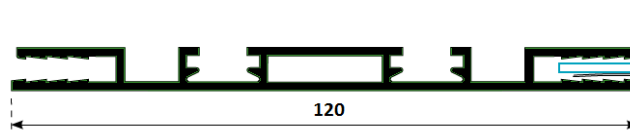



ECOPLUS 120/2

Aluminium profile for double side luminous frames with keder-edged tensioned fabrics.
 For small-to-medium suspended or self-standing frames.
 Corner connectors come complete with grub screws.
 The use of reinforcement profiles is recommended for sides longer than 1,5 m .

For LED modules and power supplies see Ch. 6 (LED lighting).



Code	Description			€/m	€/Pcs.
	Type	Material	Colour		
EEPLUS01206	Profile 120/2 Double - 6,1 m	Aluminium	Anodized Silver	€ 26,20	€ 159,82
Cutting and coloured painting/anodizing on demand					

Accessories Code	Description	€/Pack.	Image
EEPLUSCON120	Aluminium bracket	€ 4,20	
ED185PF020	Support bracket 25 mm with holes incl. for 30x30x2 reinforcements (to be fixed with FVIT15C screws)	€ 3,99	
ED196PF017	Reinforcement square tube 30x30x2 RAL 9016, 6 m	€ 10,61	
FVIT15C	500 pcs. package of 15 mm 6 MA screws	see page 4.12	
FDADOC	500 pcs. package of 6 MA hexagonal nuts	€ 20,99	
EOMFKIT	2 pcs. package of standard suspension kit	€ 21,24	
ED100PF010	3x14 transparent blue PVC flat keder 200 m reel	€ 79,38	
ED100PF030	3x14 transparent blue PVC flat keder 200 m reel	€ 79,38	
ED100PF020	7x13 grey PVC hammer keder 100 m reel	€ 207,90	
EOMFNASTRO	2,8x13,5 transparent PVC flat keder 100 m reel	€ 91,80	

PROFILES FOR DOUBLE SIDE TEXTILE LIGHTBOXES



ECOPLUS 160

ON DEMAND

Aluminium profile for double side luminous frames with keder-edged tensioned fabrics.

For medium-to-large wall-mounted, suspended or self-standing frames with feet.





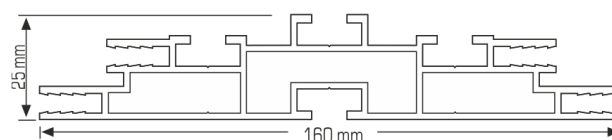



The double channel for the keder allows the application of an inner white textile to improve diffusion and to hide the electrical parts during the printed textile changeover. The use of reinforcement profiles is recommended for sides longer than 2 m. Corner connectors come complete with grub screws.

For LED modules and power supplies see Ch. 6 (LED lighting).



Code	Description			€/m	€/Pcs.
	Type	Material	Colour		
EEPLUS01606	Profile 160 Double - 6,1 m	Aluminium	Anodized silver	€ 39,64	€ 241,80
EEPLUS0160	Profile 160 Double - 3,05 m	Aluminium	Anodized silver	€ 39,64	€ 120,90

Cutting and coloured painting/anodizing on demand

Accessories Code	Description	€/Pack.	Image
EEPLUSCON100	10 pcs. package of internal L connectors	€ 27,70	
EOMFH	3,00 m of 45x16 H shaped support profiles	€ 33,30	
EOMFHCON	10 pcs. package of connectors for H profiles	€ 34,10	
EOMFOFF	Iron base 100x600 with connector	€ 49,60	
ED100PF010	3x14 transparent blue PVC flat keder 200 m reel	€ 79,38	
ED100PF030	3x14 transparent blue PVC flat keder 200 m reel	€ 79,38	
ED100PF020	7x13 grey PVC hammer keder 100 m reel	€ 207,90	
EOMFNASTRO	2,8x13,5 transparent PVC flat keder 100 m reel	€ 91,80	

PROFILES FOR DOUBLE SIDE TEXTILE LIGHTBOXES

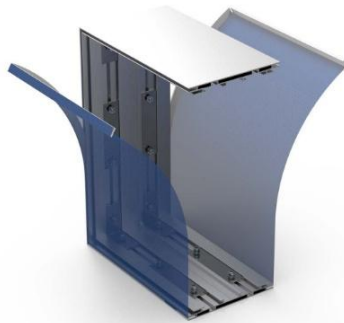

T-FLEX® 170/2

Aluminium profile for double side illuminated frames with keder-edged tensioned fabrics.
 For medium-to-large suspended or self-standing frames with feet.
 The double channel for the keder allows the application of an inner white textile to improve diffusion and to hide the electrical parts during the printed textile changeover.
 The use of reinforcement profiles is recommended for sides longer than 1,5 m.
 Corner connectors come complete with bolts and nuts.

For LED modules and power supplies see Ch. 6 (LED lighting).



Code	Description			€/m	€/Pcs.
	Type	Material	Colour		
ED370PL010	Profile T-Flex 170/2 Double - 6,1 m	Aluminium	Anodized Silver	€ 43,09	€ 262,86

Cutting and coloured painting/anodizing on demand

Accessories Code	Description	€/each	Image
ED110PF016	Corner connector FastFix	€ 3,36	
ED110PF017	Straight connector FastFix	€ 3,84	
ED196PF015	Foot B steel 400x60 RAL 9006	€ 34,59	
ED196PF016	Mounting plate for foot	€ 2,23	
LOJ06105	M5x20 screws, pack of 4	€ 2,40	
ED185PF020	Support bracket 25 mm with holes incl. for 30x30x2 reinforcements (to fix it in the middle of the profile use self drilling/threading screws)	€ 3,99	
ED196PF017	Reinforcement square tube 30x30x2 RAL 9016, 6 m	€ 10,61	
ED100PF010	3x14 transparent blue PVC flat keder 200 m reel	€ 79,38	
ED100PF030	3x14 transparent blue PVC flat keder 200 m reel	€ 79,38	
ED100PF020	7x13 grey PVC hammer keder 100 m reel	€ 207,90	
EOMFNASTRO	2,8x13,5 transparent PVC flat keder 100 m reel	€ 91,80	

PROFILES FOR TEXTILES TENSIONING

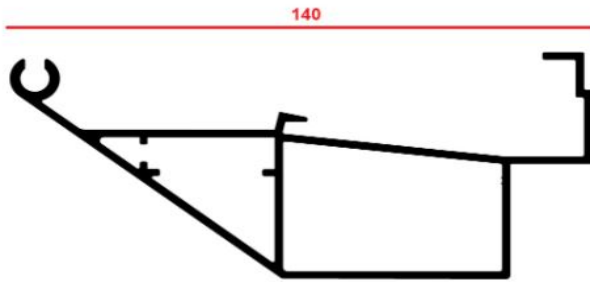

ECOPLUS 140

ON DEMAND

140 mm extruded aluminum profile prepared for the insertion of textiles tensioned and locked with a special profile. Suitable for lightboxes and large surfaces. Prepared to host LED lighting.

For LED modules and power supplies see Ch. 6 (LED lighting).

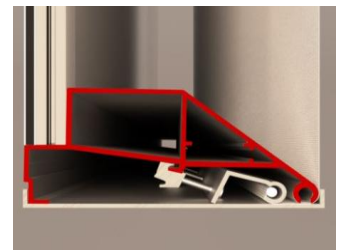
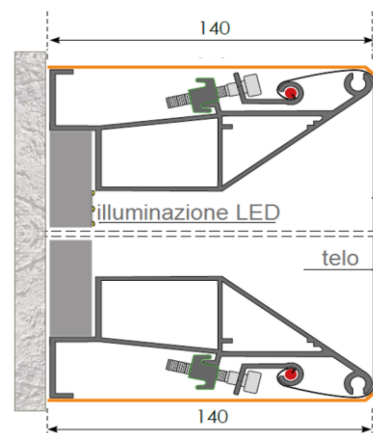

Code	Description	€/Pcs.
	Type	
SCS	On measure structure in assembly kit complete with accessories	ON QUOTE

PROFILES FOR TEXTILES TENSIONING

CRYSTAL

Crystal line, made up of a wide range of profiles, is suitable for the creation of supports of any shape: from indoor structures, perfect for tensioning pictorial canvases, to outdoor structures, necessary for mega-billboards on walls or false ceilings. The Crystal profile is light, resistant, extremely adaptable. Easy to manipulate, cut and fix, Crystal does not cause creases in the sheets and leaves ample room for the creativity of the professional.

KT+ - P100: for the realization of frames and large format external structures.
KP - KTN: for the creation of small and medium format removable frames.
C - KL+ - KTA: for the creation of interior architectures and graphics on vehicles.
JN: indoor universal closing profiles.
JR: outdoor universal closing profiles.



**Place the sheet approx. 10 cm larger.
 Secure the sheet with stoppers.
 Fit the PVC profile by removing stoppers.
 If required, cut the excess sheet.**

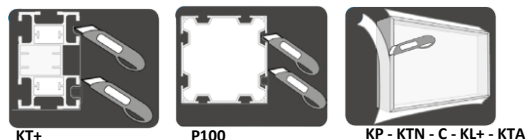

Code	Description			€/m	€/Pcs.
	Type	Material	Colour		
CGKT+	Profile KT+ - 3,5 m	Aluminium	Anodized Silver	€ 65,15	€ 228,03
CGP100	Profile P100 - 5 m	Aluminium	Anodized Silver	€ 101,33	€ 506,63

CGKT+
64 x 36,5 mm

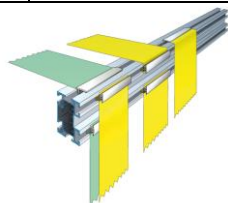

CGP100
100 x 100 mm

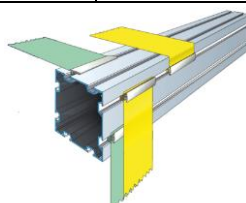

CGKP	Profile KP - 3,5 m	Aluminium	Anodized Silver	€ 21,48	€ 75,16
CGKTN	Profile KTN - 3,5 m	Aluminium	Anodized Silver	€ 18,80	€ 65,80

CGKP
34 x 20 mm

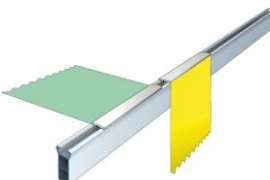

CGKTN
22 x 20 mm

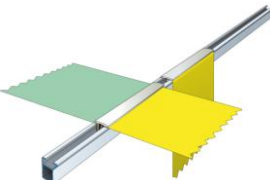

CGC	Profile C - 3,5 m	Aluminium	Anodized Silver	€ 7,00	€ 24,50
CGKL	Profile KL+ - 3,5 m	Aluminium	Anodized Silver	€ 28,40	€ 99,40
CGKTA	Profile KTA - 3,5 m	Aluminium	Anodized Silver	€ 12,43	€ 43,49

CGC
20 x 8 mm

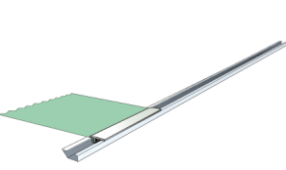

CGKL+
65 x 16 mm

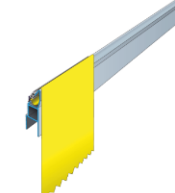

CGKTA
28 x 9 mm

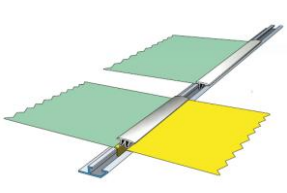

CGJN	Profile JN - 3,5 m	PVC	White	€ 3,65	€ 12,78
CGJR	Profile JR - 3,5 m	PVC	White	€ 7,30	€ 25,55

CGJN
18 x 9 mm

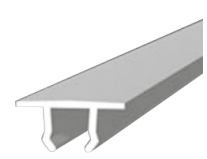

CGJR
18 x 9 mm

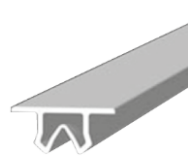

Mounting accessories available on demand

PROFILES FOR TEXTILES TENSIONING

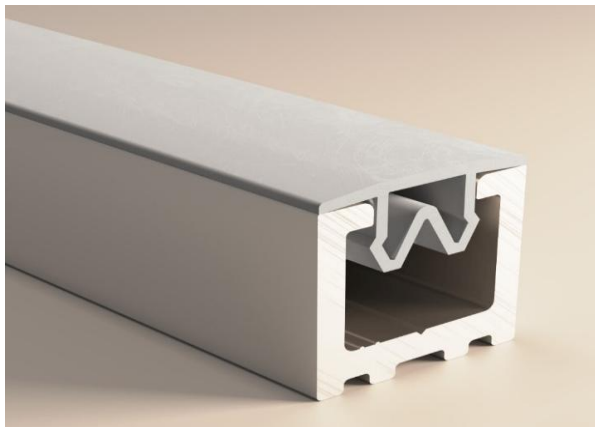

EXTENTION WALL

The XTW Extension Wall profile system allows for quick and easy tensioning of banners and printed fabrics both indoors and outdoors. It consists of two basic elements: the aluminium profile and a shockproof PVC cover RAL 7035 to be clicked onto it.

NEW LENGTH 6,05 M
45° CUT POSSIBLE

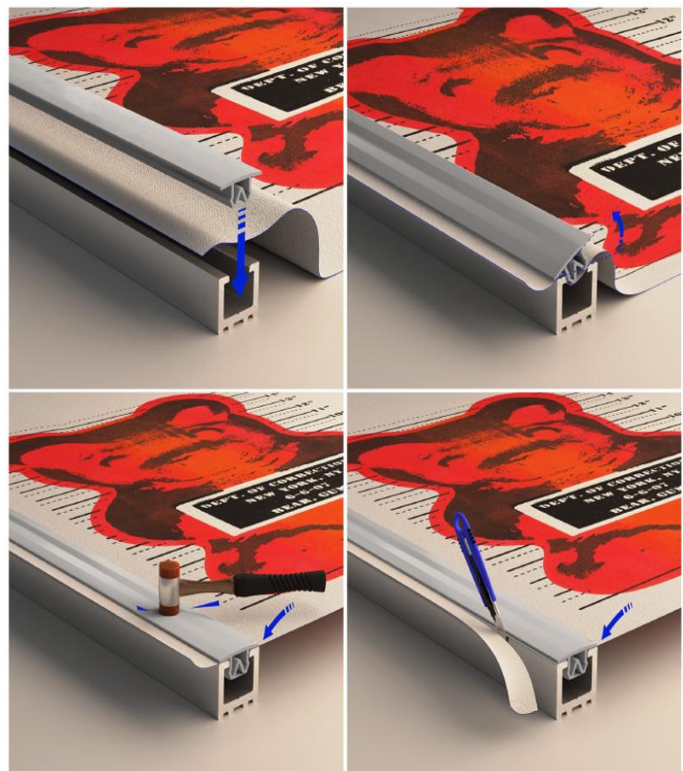

Code	Description			€/m	€/Pcs.
	Type	Material	Colour		
EEPLUS0200	Profile 6,05 m	Aluminium	Anodized Silver	€ 14,67	€ 88,03
EEPLUS0201	Profile 3,01 m	PVC	Anodized Silver	€ 5,47	€ 16,40

PROFILES FOR TEXTILES TENSIONING





KEE KLAMP JOINTS

System joints malleable cast iron easy to use, can be used with standard pipe Ø 48 mm. They offer an easy way to build tubular structures as well as an economic alternative to the welding, joints are galvanized for corrosion resistance. To firmly lock the tube into the body of the joint, just tighten the screws with the hex wrench.

For signage poles see Ch. 2 (communication systems).
 For textiles accessories see Ch. 3 (digital print)

LAST PIECES IN STOCK SPECIAL PRICE PROMOTION

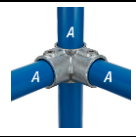

Code	Description	€/Pc.	Image
OKA128T	Hot galvanized cast iron Kee Klamp joints A12-8 T 45° opening	€ 42,60	
OK208T	Hot galvanized cast iron Kee Klamp joints 20-8 T double angle	€ 34,95	
OK258T	Hot galvanized cast iron Kee Klamp joints 25-8 Double T on line	€ 29,85	
OK728S	Hot galvanized cast iron Kee Klamp joints 72-8 Step support	€ 52,10	
OK148P	Kee Klamp cast iron joint extension 14-8	€ 23,95	
OK218P	Kee Klamp cast-iron through-joint two-way angle 21-8	€ 28,25	
Other types available on demand			

Accessories Code	Description	€/Pc.	Image
ES48300A	3 m of Ø 48 antirotation pole	€ 60,23	
ES48360A	3,6 m of Ø 48 antirotation pole	€ 72,28	

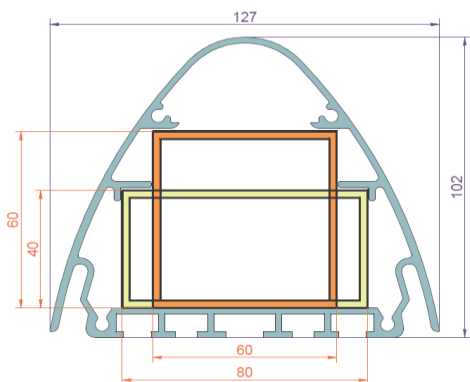

TM 100

Profile for single or double side large size totem for outdoor or indoor advertising.
A 60x60 mm or 80x40 mm square tube can be inserted inside the profile to allow the fixing onto steel plates or concrete bases.
Maximum sheet thickness: 4 mm.

For modules and power supplies see Ch. 6 (LED lighting).

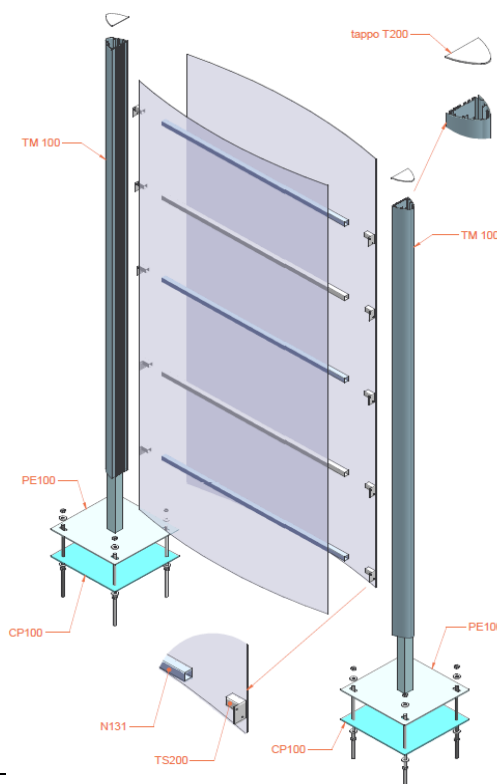

Code	Description			€/m	€/Pcs.
	Type	Material	Colour		
OPTM100A	Profile TM 100 - 6 m	Aluminium	Painted Silver RAL 9006	€ 100,75	€ 604,50
OPTM100	Profile TM 100 - 6 m	Aluminium	Mill Finish	€ 83,48	€ 500,85
ON131	Square tube 30x30x2 - 6 m	Aluminium	Mill Finish	€ 15,93	€ 95,58
Assembled Totem or in mounting kit on demand					

Accessories Code	Description	€/Pack.	Image
OPT200	Pair of aluminium caps with screws included	€ 22,85	
OPTS200	Left and right brackets	€ 40,18	
OBB135	13x13x35 8 MA screw with nut	€ 0,35	
OPTMG100	Pair of backplate with anchor bolts included	Price on demand	
OPTPE100	Pair of floor plates 50x50 with tube 60x60, 3 m height	Price on demand	

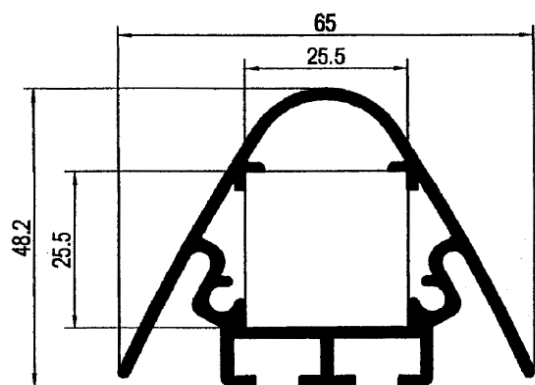

TM 500



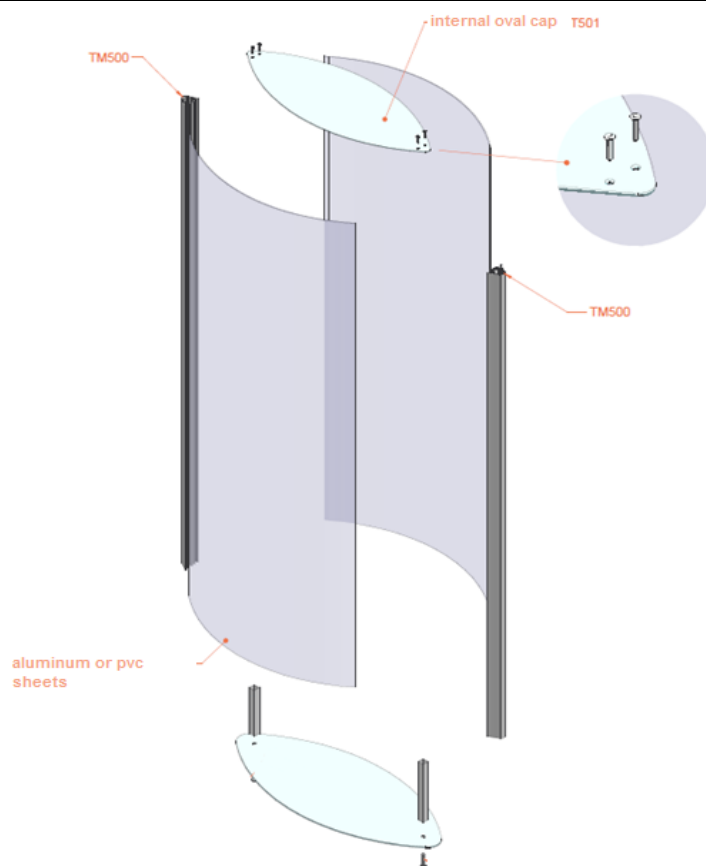

Profile for single or double side medium-large size totem for outdoor or indoor advertising.
 A 25x25 mm tube can be inserted inside the profile to allow the fixing onto steel plates or concrete bases.
 Maximum sheet thickness: 4 mm.

For modules and power supplies see Ch. 6 (LED lighting).



Code	Description			€/m	€/Pcs.
	Type	Material	Colour		
OPTM500A	Profile TM 500 - 6 m	Aluminium	Anodized Silver	€ 30,73	€ 184,35
OPTM500	Profile TM 500 - 6 m	Aluminium	Mill Finish	€ 25,33	€ 151,95
OP015111A	Square tube 15x15x1,5 - 6 m	Aluminium	Mill Finish	€ 6,13	€ 36,75

Assembled Totem or in mounting kit on demand

Accessories Code	Description	€/Pack.	Image
OPT500	Pair of PVC caps	€ 12,83	
OPTS500	Left and right brackets	€ 24,18	
OBB130	13x13 6 MA screw with nut	€ 0,15	
OPPI500	Pair of floor plates with tube 25x25,1 m height	Price on demand	

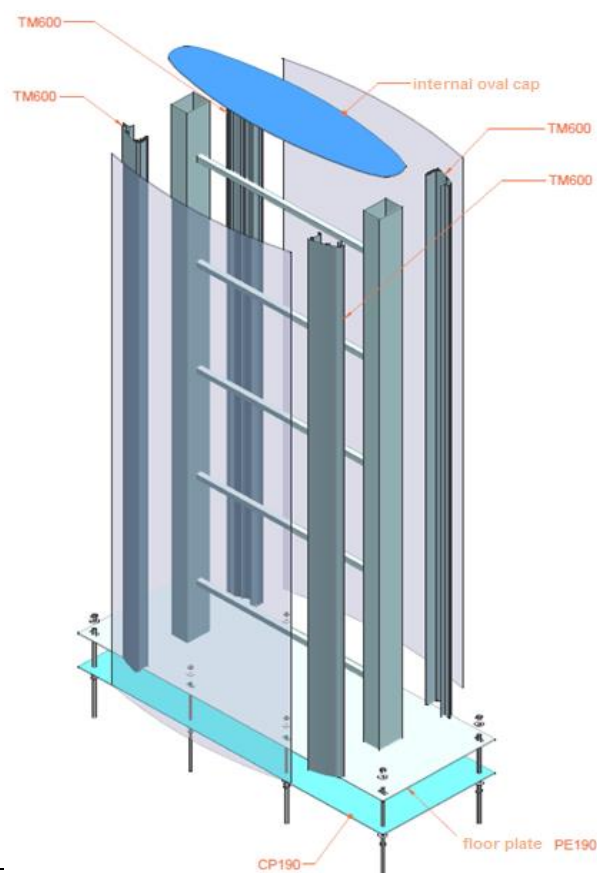
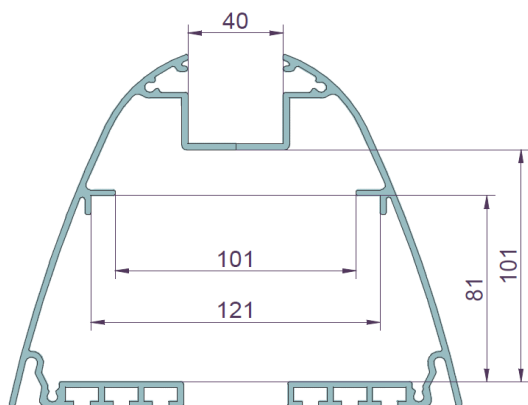

TM 600

Profile for single or double side large size totem for outdoor advertising.
This is not a self-standing profile with its own connecting system.
It has to be placed as a cover onto a pre-existing iron structure made with 100x100 mm or 120x80 mm square tubes can be inserted inside the profile to allow the fixing onto steel plates or concrete bases.
The channel on the outer edge allows the installation of a decorative linear illumination.
Maximum sheet thickness: 4 mm.

For modules and power supplies see Ch. 6 (LED lighting).

Code	Description			€/m	€/Pcs.
	Type	Material	Colour		
OPTM600A	Profile TM 600 - 6 m	Aluminium	Anodized Silver	€ 69,40	€ 416,40
OPTM600	Profile TM 600 - 6 m	Aluminium	Mill Finish	€ 62,03	€ 372,15

Assembled Totem or in mounting kit on demand

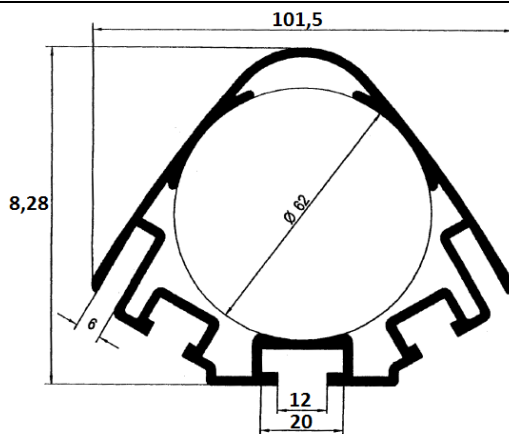

TM 300



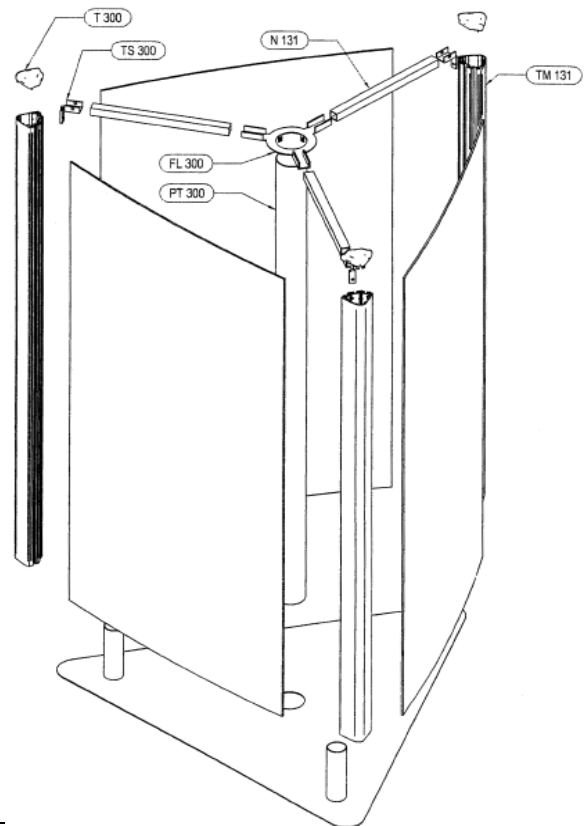

Profile for triple side medium-large size totem for outdoor or indoor advertising.
 A 60 mm round tube can be inserted inside the profile to allow the fixing onto steel plates or concrete bases.
 Maximum sheet thickness: 5 mm.

For modules and power supplies see Ch. 6 (LED lighting).

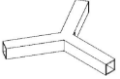
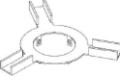

Code	Description			€/m	€/Pcs.
	Type	Material	Colour		
OPTM300A	Profile TM 300 - 6 m	Aluminium	Anodized Silver	€ 70,75	€ 424,50
OPTM300	Profile TM 300 - 6 m	Aluminium	Mill Finish	€ 57,30	€ 343,80
ON131	Square tube 30x30x2 - 6 m	Aluminium	Mill Finish	€ 15,93	€ 95,58

Assembled Totem or in mounting kit on demand

Accessories Code	Description	€/Pack.	Image
OPT300	PVC cap	€ 8,50	
OPTS300	Bracket with screws and nuts included	€ 22,00	
OBB135	13x13x35 8 MA screw with nut	€ 0,35	
OPTY300	Connection for tubes 25x25x2	€ 20,28	
OPFL300	4 mm centrale flange for Ø 100 mm pole	€ 83,70	
OPP B300	Floor plate for double sided structure with Ø 60 mm tube	Price on demand	

PROFILES FOR RIGID PANELS

FRAME PROFILES





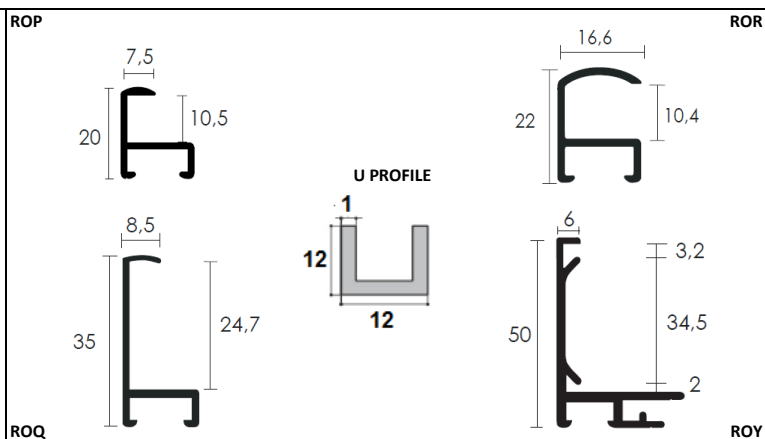

ROP: basic profile with simple design for the finishing of panels up to 10 mm thick.
ROR: to have a more visible aluminium edge all around the picture.
ROQ: to edge thicker panels or to give the impression of high thickness with a thinner panel.
ROY: for frames with protective glass or for thin LED lightboxes.
U: only for 10 mm thick panels.

For rigid panels see Ch. 1 (plastic material).
 For LED modules and power supplies see Ch. 6 (LED lighting).

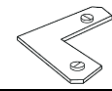

Code	Description			€/m	€/Pcs.
	Type	Material	Colour		
EROP4000A	Prof. ROP 4000 - 3 m	Aluminium	Anodized Silver	€ 5,83	€ 17,49
EROP2000O	Prof. ROP 2000 - 3 m	Aluminium	Gloss Gold	€ 7,82	€ 23,46
EROP1000B	Prof. ROP 1000 - 3 m	Aluminium	White	€ 7,45	€ 22,35
EROP5000N	Prof. ROP 5000 - 3 m	Aluminium	Black	€ 7,45	€ 22,35
EROP6000O	Prof. ROP 6000 - 3 m	Aluminium	Anodized Gold	€ 7,45	€ 22,35
EROP8000A	Prof. ROP 8000 - 3 m	Aluminium	Gloss Silver	€ 11,10	€ 33,30
EROR4000A	Prof. ROR 4000 - 3 m	Aluminium	Anodized Silver	€ 13,42	€ 40,26
EROQ4000A	Prof. ROQ 4000 - 3 m	Aluminium	Anodized Silver	€ 13,51	€ 40,53
EROQ9000N	Prof. ROQ 9000 - 3 m	Aluminium	Anodized Black	€ 15,12	€ 45,36
EROY4000A	Prof. ROY 4000 - 3 m	Aluminium	Anodized Silver	€ 34,63	€ 103,89
NZUN00 <small>phase out</small>	Prof. U - 3 m	Aluminium	Black	€ 2,83	€ 8,50

For quantities cutting and coloured painting/anodizing on demand

Accessories Code	Description	€/Pack.	Image
EROA10000	Compensation spring thickness	€ 0,41	
EROA20000	Hooks for aluminium frames	€ 0,84	
EROA300000	Angle plate and counterplate	€ 1,19	
NZCGAPAN	200 pcs. package of self adhesive click in plastic 50 x 35 mm	€ 102,38	
NZFACL	200 pcs. package of click for lightweight panels, Sandwich paper and KAPA panels	€ 108,00	
NZCGAPVC	100 pcs. package of click for PVC panels semi-expanded and Sandwich PVC	€ 120,00	

PROFILES FOR RIGID PANELS

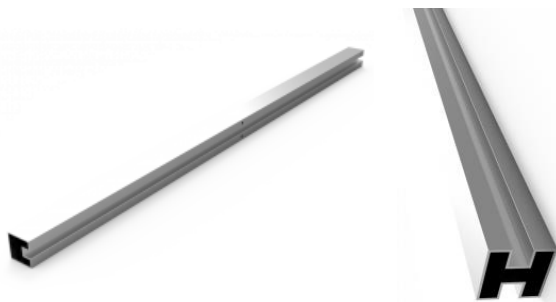





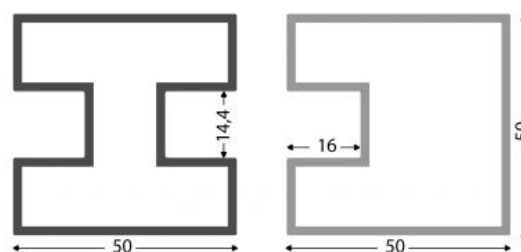



TERRACE® 50

Profile system for separation screens with glass or plastic panels.
 Perfect for social-distancing.
 Very simple with just two kind of profiles, doesn't need mitred cut.
 The rubber profile is used to hold glass and plastic panels 4 to 5 mm thick.
 The single side adhesive foam tape is used to compensate the thickness of 8 to 10 mm thick panels.
 The very wide steel feet make the screens both stable and movable.



Code	Description			€/m	€/Pcs.
	Type	Material	Colour		
ED650PF010	Prof. Terrace C - 6,1 m	Aluminium	Anodized Silver	€ 22,70	€ 138,47
ED650PF011	Prof. Terrace H - 6,1 m	Aluminium	Anodized Silver	€ 26,85	€ 163,79
ED650PF100	Glass rubber - 100 m	Aluminium	Anodized Silver	€ 7,20	€ 720,00

Cutting on demand

Accessories Code	Description	€/Pack.	Image
ED650PF201	Anod wall mounting plate	€ 39,83	
ED650PF202	Anod collection solution	€ 20,28	
ED650PF203	Anod hinge solution	€ 19,08	
ED650PF204	White Plastic assembly block	€ 3,85	
ED650PF205	Synthetic black end piece	€ 0,88	
ED650PF206	11,9 mm of synthetic cover	€ 0,58	
ED650PF300	Steel foot	€ 82,25	
ED650PF301	Square foot	€ 70,03	
HG40311530	3 mm of monoadhesive foam SG4031, 15 mm x 30 m	€ 16,08	

PROFILES FOR RIGID PANELS

SQUAREFIX®

SquareFix is a system of square tubes and selfclamping plastic connecting pieces perfect to build Covid protections and separation.

The wide range of components adapts all situations such as pre-existing furniture. Joints have a steel core for maximum stiffness.

The single-winged profiles accepts panels of any thickness.

The panel is fixed to the wing by means of adhesive tapes, sealants or screws.

Textile walls can be made thank to the dedicated profile for fabrics.

SquareFix can be used for the construction of racks, poster displays, tables, but also for shop displays, fabric frames, signs.



PHASE OUT

Code	Description			€/m	€/Pcs.
	Type	Material	Colour		
ED600PF010	Prof. Squarefix - 6 m	Aluminium	Anodized Silver	€ 8,63	€ 51,75
ED600PF011	Prof. Squarefix single - 6 m	Aluminium	Anodized Silver	€ 11,40	€ 68,40

ED600PF010

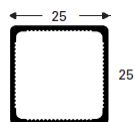
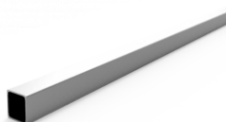

ED600PF011

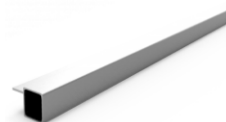

ED600PF012	Prof. Squarefix double 180° - 6 m	Aluminium	Anodized Silver	€ 13,65	€ 81,90
ED600PF013	Prof. Squarefix 90° low - 6 m	Aluminium	Anodized Silver	€ 13,58	€ 81,45

ED600PF012



ED600PF013

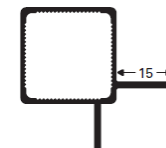
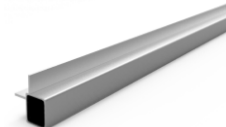

ED600PF014	Prof. Squarefix 90° high - 6 m	Aluminium	Anodized Silver	€ 13,65	€ 81,90
ED600PF015	Prof. Squarefix textile single - 6 m	Aluminium	Anodized Silver	€ 17,13	€ 102,75

ED600PF014

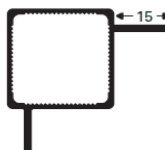
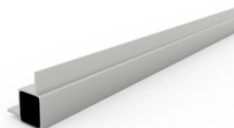



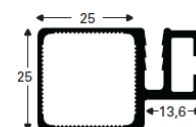
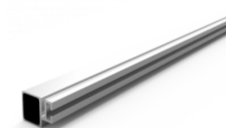







ED600PF015



Cutting on demand

ACCESSORIES FOR SQUAREFIX

PHASE OUT			
Accessories Code	Description	€/Pack.	Image
ED600PF100	25x25 black Squarefix insert cap	€ 0,78	
ED600PF101	25x25 Squarefix 2 way piece 180°	€ 2,08	
ED600PF102	25x25 Squarefix 2 way piece 90°	€ 3,73	
ED600PF103	25x25 Squarefix 3 way piece flat 180°/90°	€ 4,63	
ED600PF104	25x25 Squarefix 3 way piece 90°/90°	€ 5,20	
ED600PF105	25x25 Squarefix 4 way piece flat	€ 6,40	
ED600PF106	25x25 Squarefix 4 way piece 180°/90°	€ 6,28	
ED600PF107	25x25 Squarefix 5 way piece 180°/90°	€ 7,03	
ED600PF108	25x25 Squarefix 6 way piece 180°/90°	€ 8,93	
HG0641233	0,64 mm double adhesive Scapa A1130TP, 12 mm x 33 m	€ 33,23	

SYSTEM 25

System of aluminium square profiles and ABS joints to make cabins, boxes, walls, displays and many other self standing structures.
The structures can be assembled in the place of installation.
Profiles for panels up to 6 mm or up to 10 mm thick are available.



Code	Description			€/m	€/Pcs.
	Type	Material	Colour		
ON120	Square tube N120 - 6 m	Aluminium	Mill Finish	€ 9,88	€ 59,25
ON120A	Square tube N120 - 6 m	Aluminium	Anodized Silver	€ 12,30	€ 73,80
ON2510	Square tube N2510 - 6 m	Aluminium	Mill Finish	€ 11,68	€ 70,05
ON2510A	Square tube N2510 - 6 m	Aluminium	Anodized Silver	€ 14,60	€ 87,60

N120

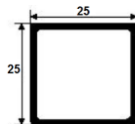

N2510

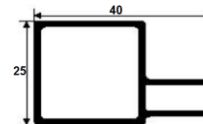

ON2520	Square tube N2520 - 6 m	Aluminium	Mill Finish	€ 14,98	€ 89,85
ON2520A	Square tube N2520 - 6 m	Aluminium	Anodized Silver	€ 18,03	€ 108,15
ON2530	Square tube N2530 - 6 m	Aluminium	Mill Finish	€ 14,93	€ 89,55
ON2530A	Square tube N2530 - 6 m	Aluminium	Anodized Silver	€ 17,98	€ 107,85

N2520

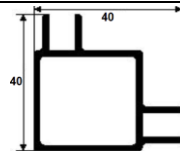

N2530

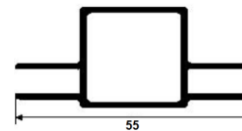

ON2540	Square tube N2540 - 6 m	Aluminium	Mill Finish	€ 13,18	€ 79,05
ON2540A	Square tube N2540 - 6 m	Aluminium	Anodized Silver	€ 15,85	€ 95,10
ON2550	Square tube N2550 - 6 m	Aluminium	Mill Finish	€ 16,80	€ 100,80
ON2550A	Square tube N2550 - 6 m	Aluminium	Anodized Silver	€ 20,25	€ 121,50

N2540

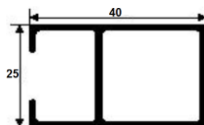

N2550

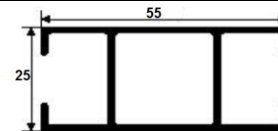





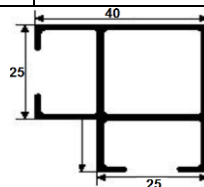



ON2560	Square tube N2560 - 6 m	Aluminium	Mill Finish	€ 16,80	€ 100,80
ON2560A	Square tube N2560 - 6 m	Aluminium	Anodized Silver	€ 20,25	€ 121,50

N2560



30 mm tubes and other colours (bronze and black) on demand
For quantities cutting on demand

Accessories Code	Description	€/Pack.	Image
OG250	Terminal cap for 25 mm tube	€ 0,75	
OG251	ABS Coupling 2 way line for 25 mm tube	€ 4,08	
OG252	ABS Coupling 2 way angle for 25 mm tube	€ 4,08	
OG253	ABS Coupling 3 way line for 25 mm tube	€ 4,43	
OG254	ABS Coupling 3 way angle for 25 mm tube	€ 4,43	
OG255	ABS Coupling 4 way line for 25 mm tube	€ 4,85	
OG256	ABS Coupling 4 way angle for 25 mm tube	€ 4,85	
OG257	ABS Coupling 5 way angle for 25 mm tube	€ 5,23	
OG258	ABS Coupling 6 way angle for 25 mm tube	€ 5,80	

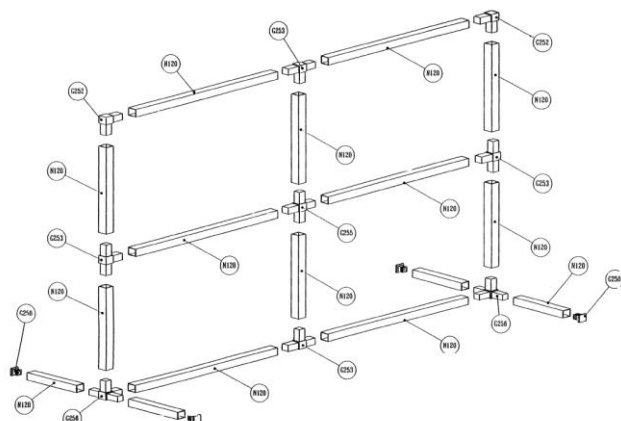
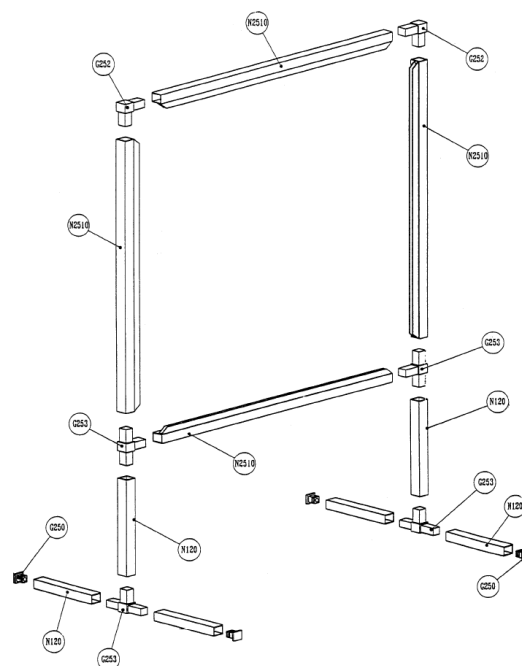
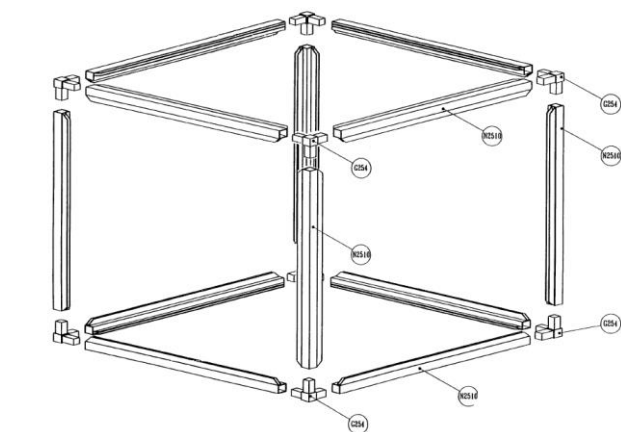



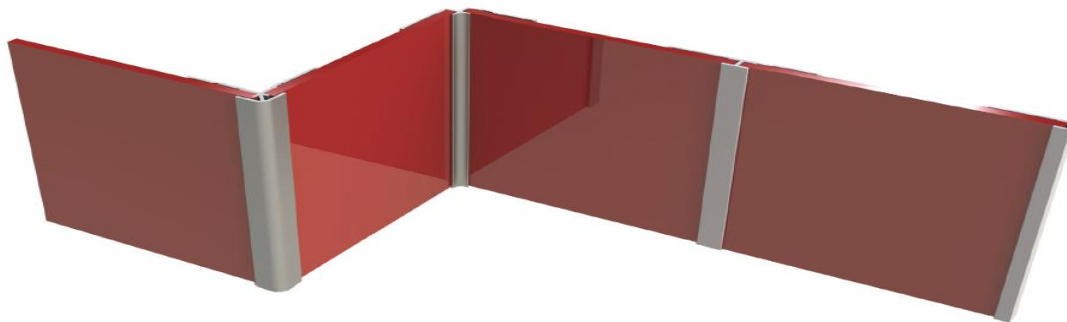



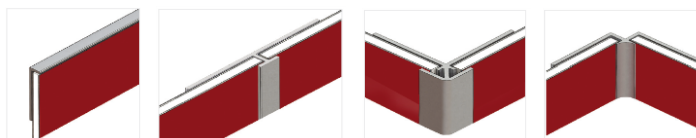

FINISHING PROFILES

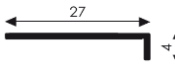
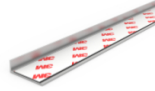
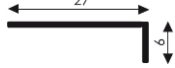
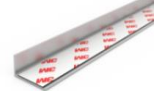

EDGETRIM ADHESIVE PROFILES FOR PANELS

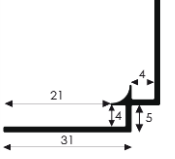
Wide range of profiles with adhesive tape in various shapes, for finishing panel edges or for linear or corner joints. In silver anodised aluminium, some are also available in anodised gold or painted dark grey RAL7021 on request. A practical, economical and quick solution for finishing and adding rigidity. On request, also available without adhesive tape.

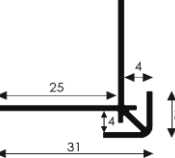

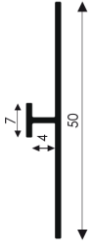
Code	Description			€/m	€/Pc.	Picture
	Type	Material	Color			
ED200AA003	L-profile 4 - 4.1 m	Aluminium Anodised silver	5,78 €	23,68 €		
ED200AA004	L-profile 6 - 4.1 m	Aluminium Anodised silver	5,90 €	24,19 €		
ED200AA005	L-profile 10 - 4.1 m	Aluminium Anodised silver	6,43 €	26,35 €		
ED200AA006	Inside corner 90° - 4.1 m	Aluminium Anodised silver	10,86 €	44,51 €		
ED200AA007	External corner 90° - 4.1 m	Aluminium Anodised silver	12,10 €	49,59 €		
ED200AA002	Connection - 4.1 m	Aluminium Anodised silver	10,63 €	43,57 €		

Customised cutting and painting/anodising in other colours on request

STRIP LED PROFILES



M PROFILE

Profile for flat surfaces

Compact profile in natural anodised extruded aluminium for LED bar realizations.

Accessories set available: caps, lens, racks, diffusers, etc.

Suitable for indoor use.



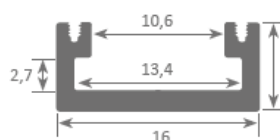

Excellent heating dissipation.

The profile is ideal for using on wall surfaces, furniture, shelves and similar areas, where we require a minimalist profile with very reduced dimensions.

For LED strip see Ch. 6 (LED lighting).



Code	Description				€/Pcs.
	Type	Material	Colour	Pcs./Pack.	
LOZ2PM01	Profile M - 2 m	Aluminium	Anodized Silver	1	€ 13,60

Accessories Code	Description	€/Pack.	Image
LOZ2PMT	10 pcs. package of grey end caps with hole	€ 9,62	
LOZ2PMT/F	10 pcs. package of grey end caps without hole	€ 9,62	
LOZ2P01/1	2 m of transparent methacrylate diffuser	€ 7,75	
LOZ2P02/1	2 m of satin methacrylate diffuser	€ 7,75	
LOZ2P03/1	2 m of opaline methacrylate diffuser	€ 7,75	
LOZ2PMG	10 pcs. package of fixing plates	€ 9,62	

STRIP LED PROFILES



R PROFILE

Profile for flat surfaces

Compact profile in natural anodised extruded aluminium for LED bar realizations.
 Accessories set available: caps, lens, racks, diffusers, etc.

Suitable for indoor use.



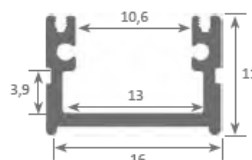

Excellent heating dissipation.

The profile is ideal for using on wall surfaces, furniture, shelves and similar areas.

For LED strip see Ch. 6 (LED lighting).



Code	Description				€/Pcs.
	Type	Material	Colour	Pcs./Pack.	
LOZ2PR01	Profile R - 2 m	Aluminium	Anodized Silver	1	€ 12,44

Accessories Code	Description	€/Pack.	Image
LOZ2PRT	10 pcs. package of grey end caps with hole	€ 9,62	
LOZ2PRT/F	10 pcs. package of grey end caps without hole	€ 9,62	
LOZ2P01/1	2 m of transparent methacrylate diffuser	€ 7,75	
LOZ2P02/1	2 m of satin methacrylate diffuser	€ 7,75	
LOZ2P03/1	2 m of opaline methacrylate diffuser	€ 7,75	
LOZ2PRG	10 pcs. package of fixing plates	€ 9,62	

STRIP LED PROFILES

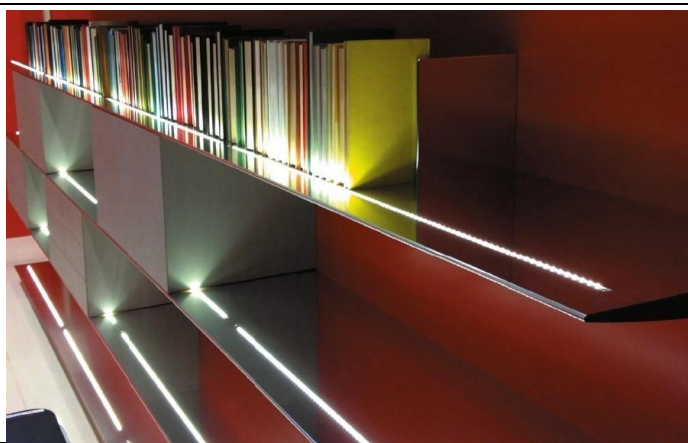

F PROFILE



Profile for embedding

Compact profile in natural anodised extruded aluminium for LED bar realizations.
 Accessories set available: caps, lens, racks, diffusers, etc.
 Suitable for indoor use.
 Excellent heating dissipation.
 Ideal for embedding in furniture, shelving and similar areas, where we require a minimalist profile with very reduced dimensions.

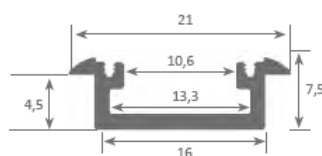
For LED strip see Ch. 6 (LED lighting).



Code	Description				€/Pcs.
	Type	Material	Colour	Pcs./Pack.	
LOZ2PF01	Profile F - 2 m	Aluminium	Anodized Silver	1	€ 14,81

Accessories Code	Description	€/Pack.	Image
LOZ2PFT/F	10 pcs. package of grey end caps without hole	€ 9,62	
LOZ2P01/1	2 m of transparent methacrylate diffuser	€ 7,75	
LOZ2P02/1	2 m of satin methacrylate diffuser	€ 7,75	
LOZ2P03/1	2 m of opaline methacrylate diffuser	€ 7,75	
LOZ2PMG	10 pcs. package of fixing plates	€ 9,62	

STRIP LED PROFILES

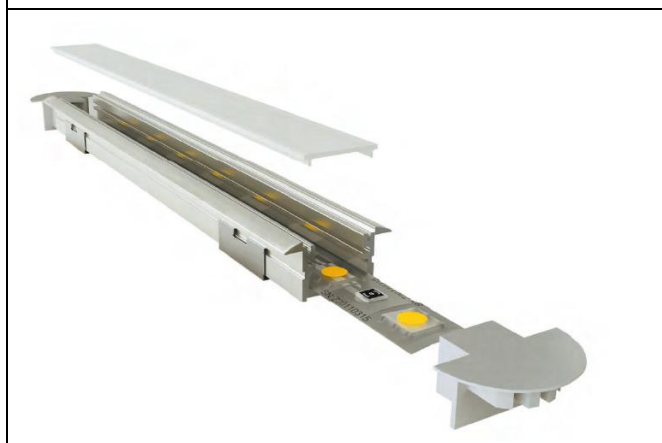

B PROFILE



Profile for embedding

Compact profile in natural anodised extruded aluminium for LED bar realizations.
 Accessories set available: caps, lens, racks, diffusers, etc.
 Suitable for indoor use.
 Excellent heating dissipation.
 Ideal for embedding in furniture, shelving and similar areas where we require a profile with a dot-free effect.

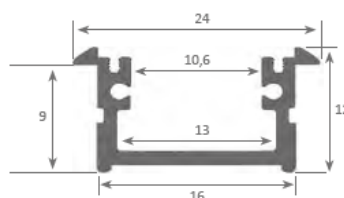
For LED strip see Ch. 6 (LED lighting).



Code	Description				€/Pcs.
	Type	Material	Colour	Pcs./Pack.	
LOZ2PB01	Profile B - 2 m	Aluminium	Anodized Silver	1	€ 13,66

Accessories Code	Description	€/Pack.	Image
LOZ2PBT/F	10 pcs. package of grey end caps without hole	€ 9,62	
LOZ2P01/1	2 m of transparent methacrylate diffuser	€ 7,75	
LOZ2P02/1	2 m of satin methacrylate diffuser	€ 7,75	
LOZ2P03/1	2 m of opaline methacrylate diffuser	€ 7,75	
LOZ2PRG	10 pcs. package of fixing plates	€ 9,62	

STRIP LED PROFILES



S PROFILE



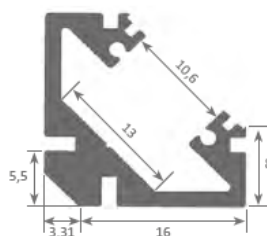

Angular profile

Compact profile in natural anodised extruded aluminium for LED bar realizations.
 Accessories set available: caps, lens, racks, diffusers, etc.
 Suitable for indoor use.
 Excellent heating dissipation.
 Ideal for wall surfaces, furniture, shelving and similar areas where we require an angled and continuous light emission along with an optimum heat dissipation.

For LED strip see Ch. 6 (LED lighting).



Code	Description				€/Pcs.
	Type	Material	Colour	Pcs./Pack.	
LOZ2PS01	Profile S - 2 m	Aluminium	Anodized Silver	1	€ 20,13

Accessories Code	Description	€/Pack.	Image
LOZ2PST	10 pcs. package of grey end caps with hole	€ 9,62	
LOZ2PST/F	10 pcs. package of grey end caps without hole	€ 9,62	
LOZ2P01/1	2 m of transparent methacrylate diffuser	€ 7,75	
LOZ2P02/1	2 m of satin methacrylate diffuser	€ 7,75	
LOZ2P03/1	2 m of opaline methacrylate diffuser	€ 7,75	
LOZ2PSG	10 pcs. package of fixing plates	€ 9,62	

STRIP LED PROFILES



P PROFILE

Profile for vertical and horizontal light bars

Compact profile in natural anodised extruded aluminium for LED bar realizations.

Accessories set available: caps, lens, racks, diffusers, etc.

Suitable for indoor use.



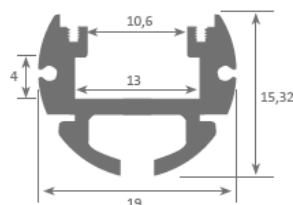

Excellent heating dissipation.

The profile has a wide range of applications, examples of which include ceiling suspended luminaires, luminaires for displaying paintings, wardrobe garment rails, floor or wall mounted luminaires, etc.

For LED strip see Ch. 6 (LED lighting).



Code	Description				€/Pcs.
	Type	Material	Colour	Pcs./Pack.	
LOZ2PP01	Profile P - 2 m	Aluminium	Anodized Silver	1	€ 19,24

Accessories Code	Description	€/Pack.	Image
LOZ2PPT	10 pcs. package of grey end caps with hole	€ 9,62	
LOZ2PPT/F	10 pcs. package of grey end caps without hole	€ 9,62	
LOZ2P01/1	2 m of transparent methacrylate diffuser	€ 7,75	
LOZ2P02/1	2 m of satin methacrylate diffuser	€ 7,75	
LOZ2P03/1	2 m of opaline methacrylate diffuser	€ 7,75	
LOZ2PPG	10 pcs. package of fixing plates	€ 18,35	

STRIP LED PROFILES



D PROFILE



Workable waterproof profile

Compact profile in natural anodised extruded aluminium for LED bar realizations.
 End caps and covers included.
 Suitable for indoor use.
 Excellent heating dissipation.
 Suitable for a wide range of floor lighting, for example stairs, bathrooms and theatres, amongst others.

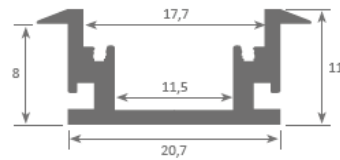
For LED strip see Ch. 6 (LED lighting).



Code	Description				€/Pcs.
	Type	Material	Colour	Pcs./Pack.	
LOZ2PD01	Profile D - 2 m	Aluminium	Anodized Silver	1	€ 19,24

Accessories Code	Description	€/Pack.	Image
LOZ2PDT/F	10 pcs. package of aluminium end caps	€ 27,03	
LOZ2PDOC	2 m of opaline methacrylate diffuser	€ 13,82	
LOZ2P000	Sealant silicone	€ 14,42	

STRIP LED PROFILES



H PROFILE



Profile for ceiling or wall mounting

Compact profile in natural anodised extruded aluminium for LED bar realizations.
 End caps included.
 Suitable for indoor use.
 Excellent heating dissipation.
 This profile can be used for many different purposes, such as ceilings and signage, due to its ultra thin methacrylate with optical effect.
 Its etched methacrylate surface makes it ideal for hanging (display signs with diffused lighting).

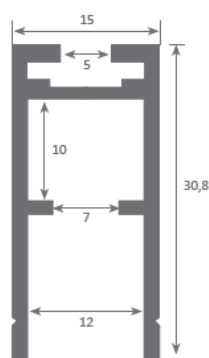
For LED strip see Ch. 6 (LED lighting).



Code	Description				€/Pcs.
	Type	Material	Colour	Pcs./Pack.	
LOZ2PH01	Profile H - 3 m	Aluminium	Anodized Silver	1	€ 35,18

Accessories Code	Description	€/Pack.	Image
LOZ2PHT/F	10 pcs. package of grey end caps without hole	€ 25,21	
LOZ2PHSQ	10 pcs. package of steel brackets	€ 16,36	

STRIP LED PROFILES

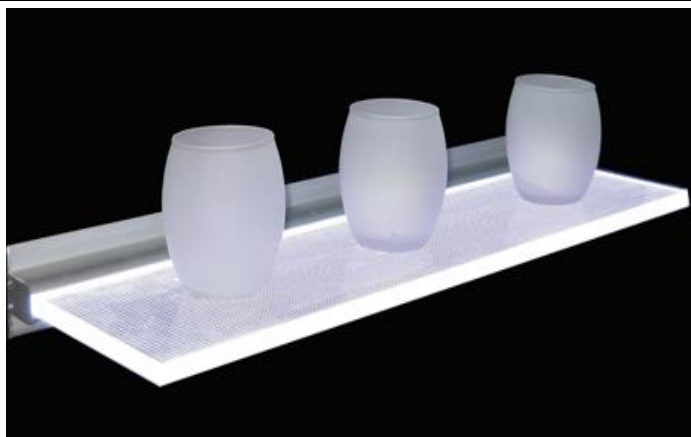

G PROFILE

Profile for shelves and counter displays

Compact profile in natural anodised extruded aluminium for LED bar realizations.
 End caps included.
 Suitable for indoor use.
 Excellent heating dissipation.
 This profile can be used for many different purposes, such as wall or table signage, due to its etched methacrylate surface (display signs with diffused lighting).

For LED strip see Ch. 6 (LED lighting).

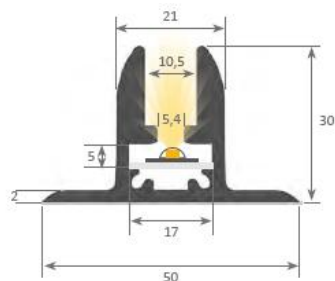

Code	Description				€/Pcs.
	Type	Material	Colour	Pcs./Pack.	
LOZ2PG01	Profile G - 3 m	Aluminium	Anodized Silver	1	€ 67,69

Accessories Code	Description	€/Pack.	Image
LOZ2PGT/F	10 pcs. package of aluminium end caps with fixing holes	€ 28,96	

STRIP LED PROFILES

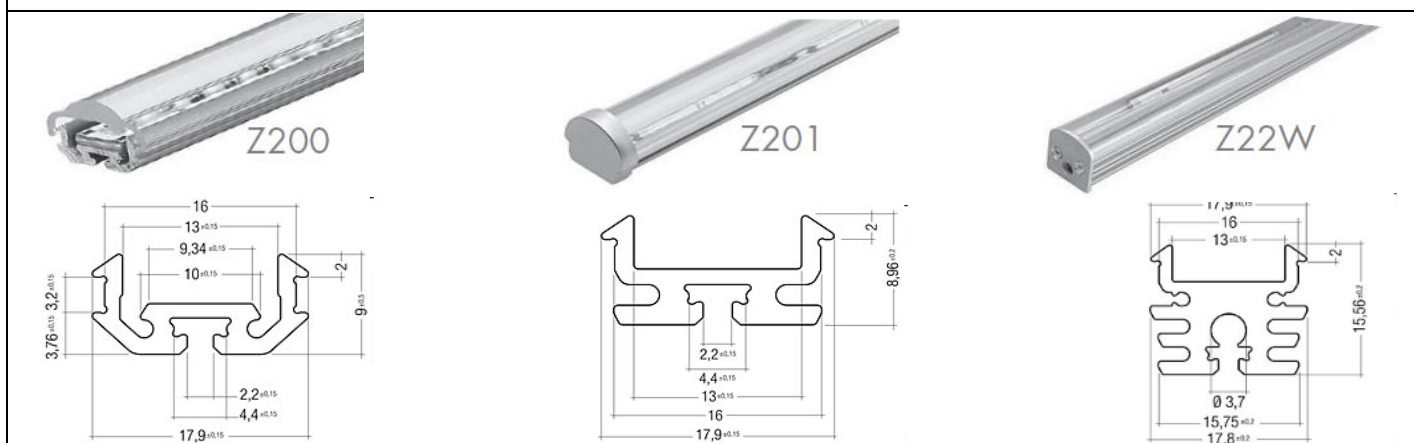

TALEXX Z200/Z201/Z22W PROFILES

Compact profile in natural anodized extruded aluminium for special LED systems realizations.

Suitable for indoor use.









Excellent heating dissipation.

Accessories set available: caps, lens, racks, diffusers, etc.

For LED strip see Ch. 6 (LED lighting).



Code	Description				€/Pcs.
	Type	Material	Colour	Pcs./Pack.	
LOZ200	TALEXX Z200 - 2 m	Aluminium	Anodized Silver	1	€ 16,90
LOZ201	TALEXX Z201 - 2 m	Aluminium	Anodized Silver	1	€ 15,20
LOZ22W	TALEXX Z22W - 2 m	Aluminium	Anodized Silver	1	€ 30,30

Accessories Code	Description	€/Pack.	Image
LOZ201T	Grey PMMA end cap (Z201)	€ 0,50	
LOZ22WT	Aluminium end cap with hole for cable entry (Z22W)	€ 1,70	
LOZ22WTF	Aluminium end cap without hole (Z22W)	€ 1,70	
LOZ22WP	Adjustable fixing plate	€ 3,00	
LOZ161	Fixing plate (Z201)	€ 0,90	
LOZ1P 15-30-45-60	Fixing plate 15°- 30°- 45°- 60°	€ 3,50	
LOZ00 30-60-90	PMMA transparent lens 30°- 60°- 90°	€ 16,40	
LOZ220 LOZ221 LOZ222	PMMA transparent cover PMMA frosted cover PMMA white cover	€ 10,00 € 10,80 € 11,70	

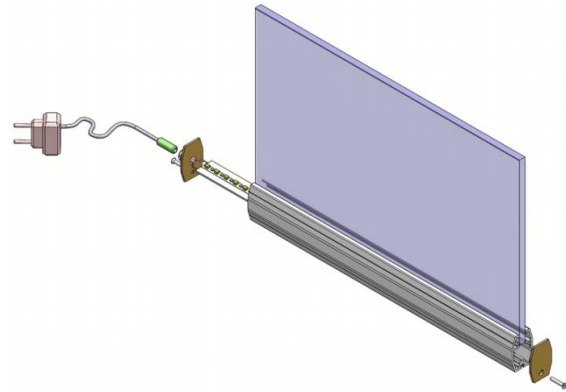
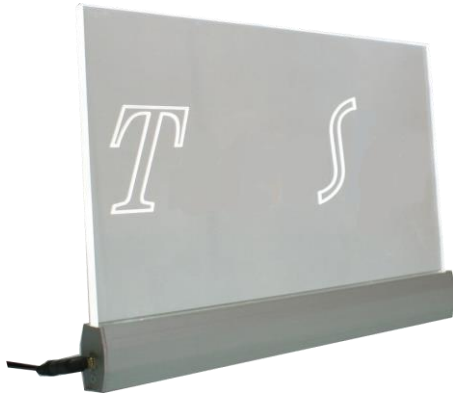



N2008 PROFILE

Compact profile in natural anodised extruded aluminium for special LED systems realizations.
 Suitable for indoor use.
 Excellent heating dissipation.
 End caps included.
 Suitable for filter-ray signs.
 Suitable for 8,5 mm PMMA sheets.

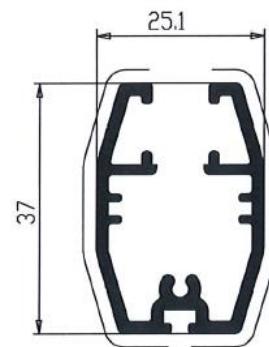
For LED strip see Ch. 6 (LED lighting).



Code	Description				€/Pcs.
	Type	Material	Colour	€/m	
OPUBL2008A	N2008 - 6 m	Aluminium	Anodized Silver	€ 14,32	€ 85,92

Accessories Code	Description	€/Pack.	Image
OT2801	End cap with or without hole	€ 3,04	
OT2802	Hanging end cap with or without hole	€ 3,04	
OT2803	Standing end cap with or without hole	€ 3,04	

CHANNEL LETTERS PROFILES

ALURAPID

Aluminium profile for easy and quick production of channel letters and lightboxes. Very light and highly flexible it enables to make letters with very sharp angles. A pneumatic machine enables also to the production of channel letters of large dimensions.

For rigid panels see Ch. 1 (plastic material).

For LED modules and power supplies see Ch. 6 (LED lighting).

ON DEMAND



JEWELITE F LETTER TRIM

Plastic mouldings with aluminium core that add new dimension to channel letters. No painting or polishing necessary. Fast fixturing with self tapping screws.

Suitable for use on 3 mm PMMA sheets.

For rigid panels see Ch. 1 (plastic material).

For LED modules and power supplies see Ch. 6 (LED lighting).







Code	Description				€/m
	Type	Material	Colour	m/Pack.	
KCHF25B	Trim Jewelite - 25 mm Height	Aluminium	White	4	ON DEMAND
KCHF25N	Trim Jewelite - 25 mm Height	Aluminium	Black	4	ON DEMAND
KCHF25R	Trim Jewelite - 25 mm Height	Aluminium	Red	4	ON DEMAND
KCHF25V	Trim Jewelite - 25 mm Height	Aluminium	Green	4	ON DEMAND
KCHF25BL	Trim Jewelite - 25 mm Height	Aluminium	Blue	4	ON DEMAND
KCHF25G	Trim Jewelite - 25 mm Height	Aluminium	Yellow	4	ON DEMAND
Angle-shaping accessories on demand					

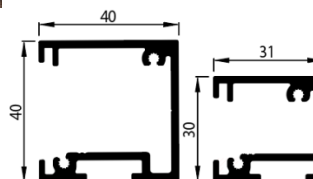

BOXLETTER CABLE CHANNEL

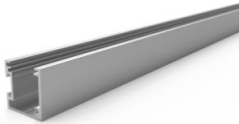
Practical wall mounting and wiring system for box letters. The cable channels are fixed to the wall by means of wall brackets, and can slide on them for optimal positioning. The letters are then fixed to the channel. The number of channels required is determined by the height of the letters. Fixing the cables within the aluminium cable duct increases reliability and safety, particularly with regard to fire propagation.

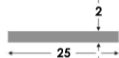

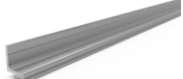
Code	Description			€/m	€/Pc.	Picture
	Type	Material	Color			
ED200CC001	Canal 30 mm Length: 6.1m	Aluminium	mill finish	11,72 €	71,48 €	
ED200CC002	Channel 40 mm Length: 6.1m	Aluminium	mill finish	15,56 €	94,92 €	
ED200CC003	End cap for 30 mm gutter	Aluminium	mill finish		6,62 €	
ED200CC004	End cap for 40 mm gutter	Aluminium	mill finish		6,74 €	
ED200CC005	Flat bar 25x2 mm MT 6	Aluminium	mill finish	ON DEMAND		
ED200CC006	Flat bar 35x2 mm 6 m	Aluminium	mill finish	ON DEMAND		
ED200CC007	Wall bracket for channel 80 mm	Aluminium	mill finish		5,23 €	
ED200CC008	Wall support profile 6.1 m	Aluminium	mill finish	10,16 €	62,00 €	

Customised cutting and painting/anodising in other colours on request