

CHAPTER FOUR

profiles

| | | Date |
|------------|--|------------------|
| | PVC PROFILES FOR LIGHTBOXES | |
| Pag. 4.01 | SYSTEM 4 | May 2026 |
| Pag. 4.02 | SYSTEM L | May 2026 |
| Pag. 4.03 | MARTINA PROFILES | ON DEMAND |
| | ALUMINIUM PROFILES FOR LIGHTBOXES | |
| Pag. 4.07 | NEX LINE PROFILES 80 | November 2025 |
| Pag. 4.08 | NEX LINE PROFILES 120 | November 2025 |
| Pag. 4.09 | NEX LINE PROFILES 150 | May 2026 |
| Pag. 4.10 | NEX LINE PROFILES 170 | November 2025 |
| Pag. 4.11 | NEX LINE PROFILES 200 | November 2025 |
| Pag. 4.12 | PROFILES 80 | April 2026 |
| Pag. 4.13 | PROFILES 120 | April 2026 |
| Pag. 4.14 | PROFILES 150 | April 2026 |
| Pag. 4.15 | PROFILES 163 | April 2026 |
| Pag. 4.16 | PROFILES 186 | May 2026 |
| | PROFILES FOR SINGLE SIDE TEXTILE FRAMES | |
| Pag. 4.20 | T-FLEX 9/1 RETROFIT | February 2025 |
| Pag. 4.21 | ECOPLUS SIMPLEX | June 2024 |
| Pag. 4.22 | ECOPLUS ACE | June 2024 |
| | PROFILES FOR TEXTILE FRAMES AND STRUCTURES | |
| Pag. 4.25 | ECOPLUS DAME | June 2024 |
| Pag. 4.26 | ECOPLUS KING | July 2023 |
| 4.26A | T-FLEX 46/2 BASIC | February 2025 |
| Pag. 4.27 | ECOPLUS 80 | June 2024 |
| | PROFILES FOR SINGLE SIDE TEXTILE LIGHTBOXES | |
| Pag. 4.30 | ECOPLUS 55 | February 2025 |
| Pag. 4.31 | ECOPLUS MAXI | March 2026 |
| Pag. 4.33 | T-FLEX 100 | January 2026 |
| Pag. 4.34 | ECOPLUS 110 | ON DEMAND |
| Pag. 4.35 | T-FLEX 150 | January 2026 |
| | PROFILES FOR DOUBLE SIDE TEXTILE LIGHTBOXES | |
| Pag. 4.40 | T-FLEX 96/2 | January 2026 |
| Pag. 4.40A | T-FLEX 120/2 | January 2026 |
| Pag. 4.41 | ECOPLUS 120/2 | February 2025 |
| Pag. 4.42 | ECOPLUS 160 | ON DEMAND |
| Pag. 4.43 | T-FLEX 170/2 | January 2026 |
| | PROFILES FOR TEXTILES TENSIONING | |
| Pag. 4.46 | ECOPLUS 140 | January 2021 |
| Pag. 4.47 | CRYSTAL | February 2026 |
| Pag. 4.47B | EXTENTION WALL | March 2026 |
| Pag. 4.48 | KEE KLAMP JOINTS | December 2024 |
| | TOTEM SYSTEM | |
| Pag. 4.50 | TM100 PROFILES FOR 2 SIDES TOTEMS | May 2026 |
| Pag. 4.51 | TM500 PROFILES FOR 2 SIDES TOTEMS | February 2022 |
| Pag. 4.52 | TM600 PROFILES FOR 2 SIDES TOTEMS | February 2022 |
| Pag. 4.53 | TM300 PROFILES FOR 3 SIDES TOTEMS | May 2026 |
| | PROFILES FOR RIGID PANELS | |
| Pag. 4.56 | PANEL FRAME PROFILES | June 2026 |
| Pag. 4.57 | TERRACE | February 2025 |
| Pag. 4.58 | SQUAREFIX | May 2023 |
| Pag. 4.58A | ACCESSORIES FOR SQUAREFIX | May 2023 |
| Pag. 4.59 | SYSTEM 25 | May 2026 |
| Pag. 4.59A | ACCESSORIES FOR SYSTEM 25 | February 2022 |
| Pag. 4.60 | EDGETRIM ADHESIVE PROFILES FOR PANELS | February 2025 |

| | | |
|------|---------------------------------|---------------------------------------|
| | STRIP LED PROFILES | |
| Pag. | 4.65 | M PROFILE |
| | | May 2026 |
| Pag. | 4.66 | R PROFILE |
| | | May 2026 |
| Pag. | 4.67 | F PROFILE |
| | | May 2026 |
| Pag. | 4.68 | B PROFILE |
| | | May 2026 |
| Pag. | 4.69 | S PROFILE |
| | | May 2026 |
| Pag. | 4.70 | P PROFILE |
| | | May 2026 |
| Pag. | 4.71 | D PROFILE |
| | | May 2026 |
| Pag. | 4.72 | H PROFILE |
| | | May 2026 |
| Pag. | 4.73 | G PROFILE |
| | | May 2026 |
| Pag. | 4.74 | TALEXX PROFILES Z200/Z201/Z22W |
| | | April 2023 |
| Pag. | 4.75 | N2008 PROFILE |
| | | August 2025 |
| | CHANNEL LETTERS PROFILES | |
| Pag. | 4.78 | JEWELITE F LETTER TRIM |
| | | ON DEMAND |
| Pag. | 4.79 | BOXLETTER CABLE CHANNEL |
| | | April 2026 |

GENERAL SALES CONDITIONS

INTRODUCTION

All the hereunder conditions are intended and accepted for each order you send to us.

Prices do not include VAT and extra fees eventually needed. Any change in prices will be agreed before the delivery.

1. ORDERS

All orders are accepted and executed on the basis of the following conditions, which will govern future deliveries, even when not reproduced.

All orders should be sent to us by fax or e-mail. Except in case of different agreements, we will debt a fixed contribution of € 15,00.

= (as partial reimbursement for bank and customs fees).

2. DELIVERIES

Goods are delivered at the buyer's risk.

Quoted times for delivery are not binding. Buyers cannot refuse the goods or ask for a reimbursement in case of delayed delivery.

3. COMPLAINTS AND RETURN OF GOODS

The client must check the condition of the goods upon its arrival and, in case of damage, to take the proper actions.

Shortcomings in quantity and quality may be claimed in written form, within 8 days from the receipt of the goods.

If the claim is prompt and justified, Buyers have exclusively entitlement to replacement of the products.

Abatements as well as making good of direct or indirect loss shall not be possible.

4. PAYMENTS

If the customer defaults on the payment of an invoice or an installment, any and all other outstanding invoice amounts or installments shall immediately become due and payable. Consumers shall pay interest on the money debt during the time of default of € 25,00 plus a 7 points above the base rate. As far as Business Enterprises are concerned, we reserve the right to prove and claim a higher damage caused by the delay in payment.

In these cases, we will be unable to accept and execute any further orders until the settlement has been received.

5. TECHNICAL DATA

We reserve ourselves the right to modify the technical data stated, at any time and without notice.

On request, we will give assistance to the customers for the best use of the products, on the basis of available experience.

6. CONTROVERSIES

In case of lawsuits the competent court will be the one in Treviso.

7. PRIVACY

Our privacy policy updated in accordance with articles 13-14 of EU Regulations 2016/679 is available on our website www.cmngroup.eu, section "Conditions and Privacy".

PVC PROFILES FOR LIGHTBOXES





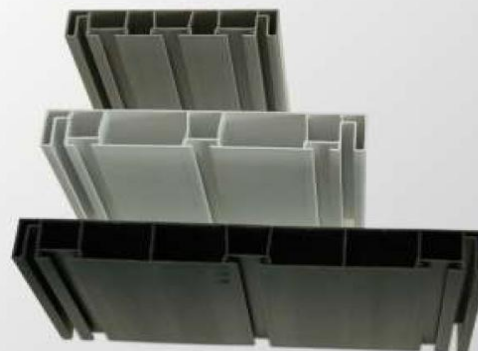

SYSTEM 4

Profiles and accessories suitable for making lightboxes with low equipment.
 Easy to cut and assemble.
 Front and bottom thickness max. 4 mm.

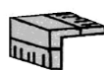

| Code | Description | | | €/m | €/Pcs. |
|----------|-----------------------------|-----------|-------------|---------|---------|
| | Type | Material | Colour | | |
| FPR90B | Profile 90 - 4 m | PVC | White | € 6,60 | € 26,39 |
| FPR90N | Profile 90 - 4 m | PVC | Black | € 6,60 | € 26,39 |
| FPR130B | Profile 130 - 4 m | PVC | White | € 9,03 | € 36,10 |
| FPR130N | Profile 130 - 4 m | PVC | Black | € 9,03 | € 36,10 |
| FPR180B | Profile 180 - 4 m | PVC | White | € 12,94 | € 51,78 |
| FPR180N | Profile 180 - 4 m | PVC | Black | € 12,94 | € 51,78 |
| FPR25 | Angular 25x25x1,5 - 4 m | PVC | White | € 2,51 | € 10,05 |
| FPR25N | Angular 25x25x1,5 - 4 m | PVC | Black | € 2,51 | € 10,05 |
| FTUBETTO | Square tube 15x15x1,5 - 4 m | Aluminium | Mill Finish | € 5,96 | € 23,85 |

Cutting on demand

| Accessories Code | Description | €/Pack. | Image |
|------------------|---|---------------|---|
| FANG90X | 90 mm PVC connection angle white/black | € 1,27 |  |
| FANG130X | 130 mm PVC connection angle white/black | € 1,49 |  |
| FANG180B | 190 mm PVC connection angle white/black | € 1,68 |  |
| FCUR130B | 130 mm PVC connection bend white/black | € 2,01 |  |
| FSQ | Zinc plated steel L bracket 25x45 | € 0,69 |  |
| FVIT15C | 500 pcs. package of 15 mm 6 MA screws | see page 4.12 |  |
| FDADOC | 500 pcs. package of 6 MA hexagonal nuts | € 35,52 |  |

Grey PVC profiles and accessories on demand

PVC PROFILES FOR LIGHTBOXES

SYSTEM L

Profiles and accessories with fitting edge to reduce the use of anti-aesthetic screws.
 Front and bottom thickness max. 4 mm.

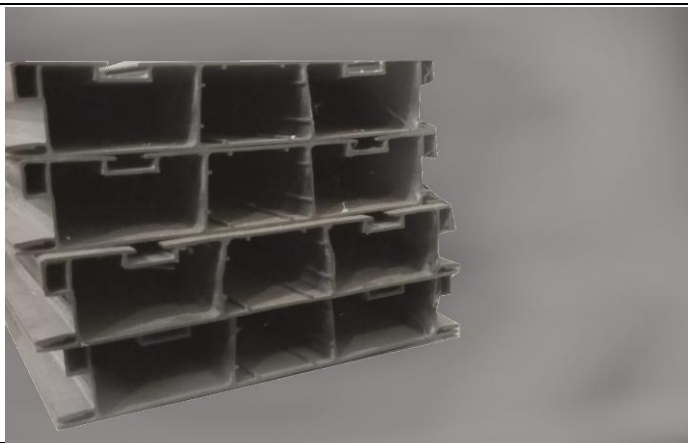

| Code | Description | | | €/m | €/Pcs. |
|----------|-----------------------------|----------|--------|---------|---------|
| | Type | Material | Colour | | |
| FPRL150B | Profile 143 - 4 m | PVC | White | € 11,73 | € 46,92 |
| FPRL150N | Profile 143 - 4 m | PVC | Black | € 11,73 | € 46,92 |
| FPR823B | Clamping angular 8x23 - 4 m | PVC | White | € 2,12 | € 8,50 |
| FPR823N | Clamping angular 8x23 - 4 m | PVC | Black | € 2,12 | € 8,50 |

Cutting on demand

| Accessories Code | Description | €/Pack. | Image |
|------------------|------------------------------|---------|---|
| FANL150X | Connection angle white/black | € 1,08 |  |

PVC PROFILES FOR LIGHTBOXES

MARTINA PROFILES

ON DEMAND

Particularly robust PVC profiles, resistant to acids and salts, suitable for making lightboxes near the sea.

They do not require external screws or bolts.







Easy to cut, assemble and install.

Front and bottom thickness max. 4 mm.



| Code | Description | | | €/m | €/Pcs. |
|----------|--------------------------|----------|--------|---------|---------|
| | Type | Material | Colour | | |
| M1100042 | Main profile 11 cm - 4 m | PVC | White | € 7,26 | € 29,04 |
| M1500040 | Main profile 15 cm - 4 m | PVC | White | € 11,26 | € 45,03 |
| M1500041 | Main profile 15 cm - 4 m | PVC | Grey | € 11,26 | € 45,03 |
| M1900040 | Main profile 19 cm - 4 m | PVC | White | € 14,02 | € 56,07 |
| M1900041 | Main profile 19 cm - 4 m | PVC | Grey | € 14,02 | € 56,07 |
| M0001040 | Clamping angular - 4 m | PVC | White | € 1,58 | € 6,32 |
| M0003040 | Clamping angular - 4 m | PVC | Grey | € 1,58 | € 6,32 |

Other colours on demand

| Accessories Code | Description | €/Pack. | Image |
|------------------|---------------------------------------|---------|---|
| M1000000 | Assembly corner for 11 cm profile | € 0,74 |  |
| M0000000 | Assembly corner for 15/19 cm profiles | € 2,60 |  |
| MCORSOIO | Slider | € 0,54 |  |
| MPIOLO | Peg | € 0,50 |  |
| M0000002 | Bracket for 11 cm profile | € 4,90 |  |
| M0000001 | Bracket for 15/19 cm profiles | € 4,90 |  |

PROFILES 80

Profile for single or double sided lightboxes with rigid front and back panels up to 4 mm thick.

The 20x20 mm L profile is fixed with screws onto the 73 mm profile to obtain a side that could be open to let the front panel slide out.

To ease mounting and internal inspection it is necessary that at least one side of the lightbox is made with these profiles, the other sides are made with the 80 mm profile.

The FSQ corners are used both to join mitred corners and to mount reinforcements made with 15x15 mm square tube.

The sides of front and back panels must be 7 mm shorter than the overall dimensions of the lightbox to accommodate thermal expansion.





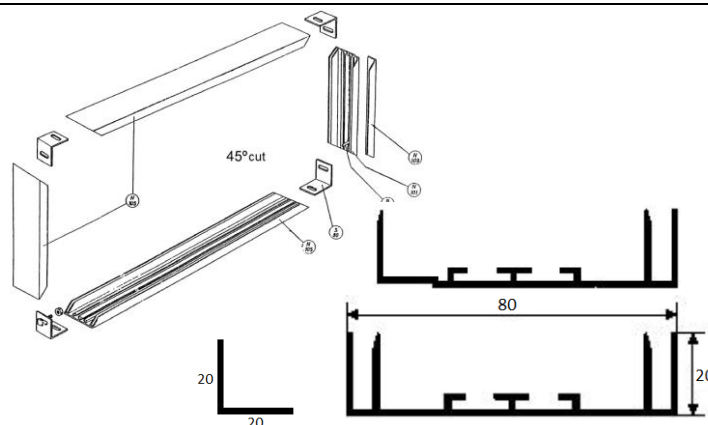



For NEON lighting see Ch. 5 (NEON lighting).

For modules and power supplies see Ch. 6 (LED lighting).



| Code | Description | | | €/m | €/Pcs. |
|-----------|-----------------------------|-----------|-----------------|---------|----------|
| | Type | Material | Colour | | |
| OP073101A | Profile 73 N101 - 6 m | Aluminium | Anodized Silver | € 21,08 | € 126,48 |
| OP080105A | Profile 80 N105 - 6 m | Aluminium | Anodized Silver | € 21,35 | € 128,10 |
| OP022109A | Angular 20x20x1,5 - 6 m | Aluminium | Anodized Silver | € 6,65 | € 39,90 |
| OP023112A | Angular 20x30x2 - 6 m | Aluminium | Anodized Silver | € 10,20 | € 61,20 |
| OP015111A | Square tube 15x15x1,5 - 6 m | Aluminium | Mill Finish | € 6,13 | € 36,75 |

Cutting, coloured painting/anodizing and curved angulars on demand

| Accessories Code | Description | €/Pack. | Image |
|------------------|---|----------|---|
| OS080A | Aluminium bracket | € 2,75 |  |
| OA080A | Aluminium connection angle | € 3,00 |  |
| OC080A | Aluminium connection bend | € 3,60 |  |
| OT119 | Cap for connection angles | € 0,68 |  |
| OTC112 | Cap for connection bend | € 1,05 |  |
| OBB130C | 500 pcs. package of 12 mm 6 MA screws with nuts | € 82,18 |  |
| OBB140C | 500 pcs. package of 40 mm 6 MA screws with nuts | € 137,28 |  |
| OPIF210 | Bracket for double sided lightboxes | € 31,07 |  |

PROFILES 120

Profile for single or double sided lightboxes with rigid front and back panels up to 4 mm thick.

The 20x20 mm L profile is fixed with screws onto the 113 mm profile to obtain a side that could be open to let the front panel slide out.

To ease mounting and internal inspection it is necessary that at least one side of the lightbox is made with these profiles, the other sides are made with the 120 mm profile. The FSQ corners are used both to join mitred corners and to mount reinforcements made with 15x15 mm square tube.

The sides of front and back panels must be 7 mm shorter than the overall dimensions of the lightbox to accommodate thermal expansion.





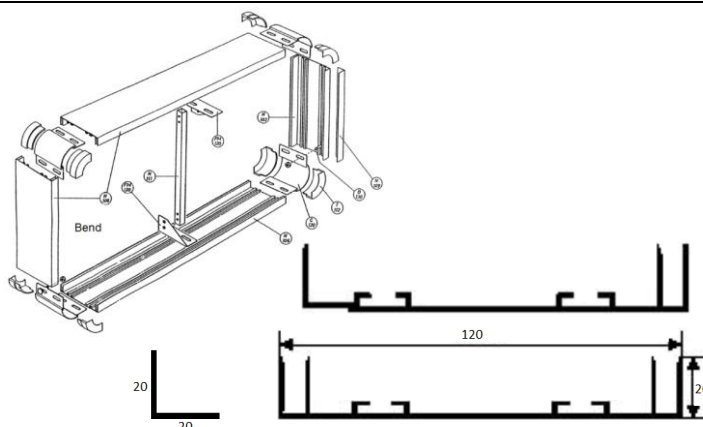



For NEON lighting see Ch. 5 (NEON lighting).

For modules and power supplies see Ch. 6 (LED lighting).



| Code | Description | | | €/m | €/Pcs. |
|-----------|-----------------------------|-----------|-----------------|---------|----------|
| | Type | Material | Colour | | |
| OP113102A | Profile 113 N102 - 6 m | Aluminium | Anodized Silver | € 23,10 | € 138,60 |
| OP120106A | Profile 120 N106 - 6 m | Aluminium | Anodized Silver | € 24,85 | € 149,10 |
| OPO22109A | Angular 20x20x1,5 - 6 m | Aluminium | Anodized Silver | € 6,65 | € 39,90 |
| OPO23112A | Angular 20x30x2 - 6 m | Aluminium | Anodized Silver | € 10,20 | € 61,20 |
| OP015111A | Square tube 15x15x1,5 - 6 m | Aluminium | Mill Finish | € 6,13 | € 36,78 |

Cutting, coloured painting/anodizing and curved angulars on demand

| Accessories Code | Description | €/Pack. | Image |
|------------------|---|----------|---|
| OS120A | Aluminium bracket | € 3,00 |  |
| OFM120A | Aluminium reinforcing bracket right or left | € 3,05 |  |
| OA120A | Aluminium connection angle | € 3,70 |  |
| OC120A | Aluminium connection bend | € 4,43 |  |
| OT119 | Cap for connection angles | € 0,68 |  |
| OTC112 | Cap for connection bend | € 1,05 |  |
| OBB130C | 500 pcs. package of 12 mm 6 MA screws with nuts | € 82,18 |  |
| OBB140C | 500 pcs. package of 40 mm 6 MA screws with nuts | € 137,28 |  |
| OPIF210 | Bracket for double sided lightboxes | € 31,07 |  |

PROFILES 150

Profile for single or double sided lightboxes with rigid front and back panels up to 4 mm thick.

The 20x20 mm L profile is fixed with screws onto the 143 mm profile to obtain a side that could be open to let the front panel slide out.

To ease mounting and internal inspection it is necessary that at least one side of the lightbox is made with these profiles, the other sides are made with the 150 mm profile. The FSQ corners are used both to join mitred corners and to mount reinforcements made with 15x15 mm square tube.

The sides of front and back panels must be 7 mm shorter than the overall dimensions of the lightbox to accommodate thermal expansion.





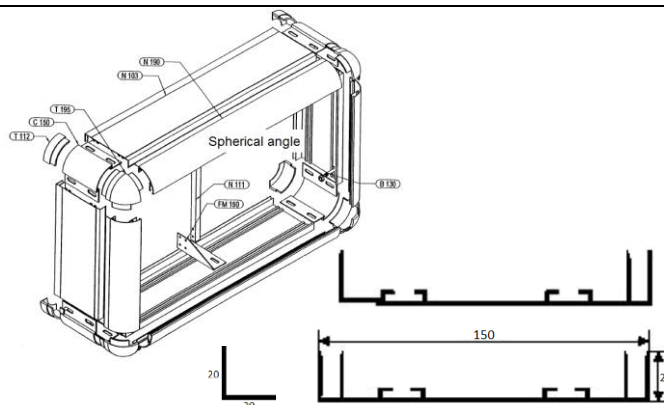



For NEON lighting see Ch. 5 (NEON lighting).

For modules and power supplies see Ch. 6 (LED lighting).



| Code | Description | | | €/m | €/Pcs. |
|-----------|-----------------------------|-----------|-----------------|---------|----------|
| | Type | Material | Colour | | |
| OP143103A | Profile 143 N103 - 6 m | Aluminium | Anodized Silver | € 30,15 | € 180,90 |
| OP150107A | Profile 150 N107 - 6 m | Aluminium | Anodized Silver | € 31,45 | € 188,70 |
| OP022109A | Angular 20x20x1,5 - 6 m | Aluminium | Anodized Silver | € 6,65 | € 39,90 |
| OP023112A | Angular 20x30x2 - 6 m | Aluminium | Anodized Silver | € 10,20 | € 61,20 |
| OP015111A | Square tube 15x15x1,5 - 6 m | Aluminium | Mill Finish | € 6,13 | € 36,75 |

Reinforcing profile 100 mm length
Cutting coloured painting/anodizing and curved angulars on demand

| Accessories Code | Description | €/Pack. | Image |
|------------------|---|----------|---|
| OS150A | Aluminium bracket | € 3,18 |  |
| OFM150A | Aluminium reinforcing bracket right or left | € 3,43 |  |
| OFR150A | Aluminium reinforcing bracket for double sided lightboxes | € 7,35 |  |
| OA150A | Aluminium connection angle | € 4,33 |  |
| OC150A | Aluminium connection bend | € 5,60 |  |
| OCF150A | Aluminium connection bend with hole | € 9,03 |  |
| OT119 | Cap for connection angles | € 0,68 |  |
| OTC112 | Cap for connection bend | € 1,05 |  |
| OBB130C | 500 pcs. package of 12 mm 6 MA screws with nuts | € 82,18 |  |
| OBB140C | 500 pcs. package of 40 mm 6 MA screws with nuts | € 137,28 |  |
| OPIF210 | Bracket for double sided lightboxes | € 31,07 |  |

PROFILES 170

Profile for single or double sided lightboxes with rigid front and back panels up to 4 mm thick.

Two 20x20 mm L profile are fixed with screws onto the 154 mm profile to obtain a side that could be open to let the front panel slide out.

To ease mounting and internal inspection it is necessary that at least one side of the lightbox is made with these profiles, the other sides are made with the 170 mm profile. The FSQ corners are used both to join mitred corners and to mount reinforcements made with 15x15 mm square tube.

The sides of front and back panels must be 7 mm shorter than the overall dimensions of the lightbox to accommodate thermal expansion.





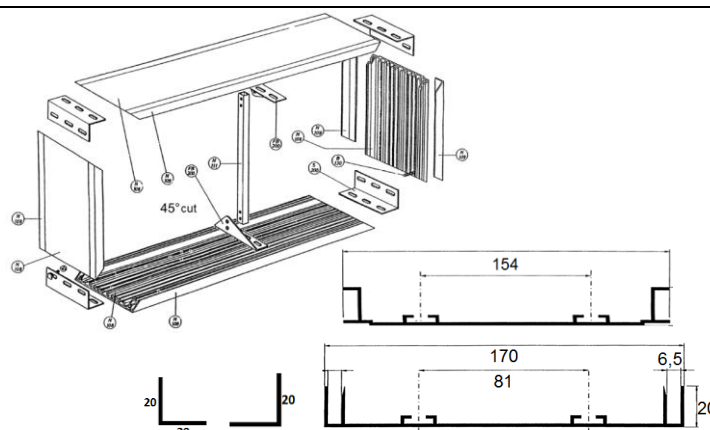





For NEON lighting see Ch. 5 (NEON lighting).

For modules and power supplies see Ch. 6 (LED lighting).



| Code | Description | | | €/m | €/Pcs. |
|-----------|-----------------------------|-----------|-----------------|---------|----------|
| | Type | Material | Colour | | |
| OP170104A | Profile 154 N104 - 6 m | Aluminium | Anodized Silver | € 29,13 | € 174,75 |
| OP170174A | Profile 170 N174 - 6 m | Aluminium | Anodized Silver | € 35,53 | € 213,15 |
| OPO22109A | Angular 20x20x1,5 - 6 m | Aluminium | Anodized Silver | € 6,65 | € 39,90 |
| OPO23112A | Angular 20x30x2 - 6 m | Aluminium | Anodized Silver | € 10,20 | € 61,20 |
| OP015111A | Square tube 15x15x1,5 - 6 m | Aluminium | Mill Finish | € 6,13 | € 36,75 |

Cutting, coloured painting/anodizing and curved angulars on demand

| Accessories Code | Description | €/Pack. | Image |
|------------------|---|----------|---|
| OS170A | Aluminium bracket. | € 3,85 |  |
| OFM170A | Aluminium reinforcing bracket right or left | € 3,70 |  |
| OA170A | Aluminium connection angle | € 5,95 |  |
| OC170A | Aluminium connection bend | € 7,38 |  |
| OCF170A | Aluminium connection bend with hole | € 10,23 |  |
| OT119 | Cap for connection angles | € 0,68 |  |
| OTC112 | Cap for connection bend | € 1,05 |  |
| OBB130C | 500 pcs. package of 12 mm 6 MA screws with nuts | € 82,18 |  |
| OBB140C | 500 pcs. package of 40 mm 6 MA screws with nuts | € 137,28 |  |
| OPIF210 | Bracket for double sided lightboxes | € 31,07 |  |

PROFILES 200

Profile for single or double sided lightboxes with rigid front and back panels up to 4 mm thick.

Two 20x20 mm L profile are fixed with screws onto the 183 mm profile to obtain a side that could be open to let the front panel slide out.

To ease mounting and internal inspection it is necessary that at least one side of the lightbox is made with these profiles, the other sides are made with the 200 mm profile. The FSQ corners are used both to join mitred corners and to mount reinforcements made with 15x15 mm square tube.

The sides of front and back panels must be 7 mm shorter than the overall dimensions of the lightbox to accommodate thermal expansion.





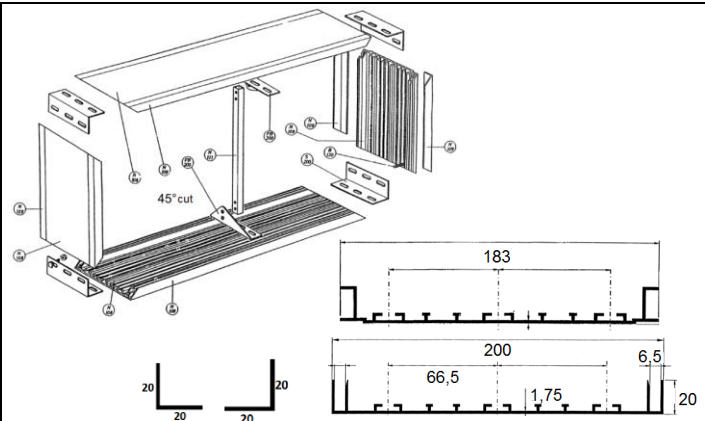





For NEON lighting see Ch. 5 (NEON lighting).

For modules and power supplies see Ch. 6 (LED lighting).



| Code | Description | | | €/m | €/Pcs. |
|-----------|-----------------------------|-----------|-----------------|---------|----------|
| | Type | Material | Colour | | |
| OP200180A | Profile 183 N180 - 6 m | Aluminium | Anodized Silver | € 42,58 | € 255,45 |
| OP200124A | Profile 200 N124 - 6 m | Aluminium | Anodized Silver | € 45,25 | € 271,50 |
| OP022109A | Angular 20x20x1,5 - 6 m | Aluminium | Anodized Silver | € 6,65 | € 39,90 |
| OP023112A | Angular 20x30x2 - 6 m | Aluminium | Anodized Silver | € 10,20 | € 61,20 |
| OP015111A | Square tube 15x15x1,5 - 6 m | Aluminium | Mill Finish | € 6,13 | € 36,75 |

Reinforcing profile 100 mm length
Cutting coloured painting/anodizing and curved angulars on demand

| Accessories Code | Description | €/Pack. | Image |
|------------------|---|----------|---|
| OS200A | Aluminium bracket | € 4,55 |  |
| OFM200A | Aluminium reinforcing bracket right or left | € 4,13 |  |
| OFR200A | Aluminium reinforcing bracket for double sided lightboxes | € 7,88 |  |
| OA200A | Aluminium connection angle | € 6,85 |  |
| OC200A | Aluminium connection bend | € 8,75 |  |
| OCF200A | Aluminium connection bend with hole | € 11,68 |  |
| OT119 | Cap for connection angles | € 0,68 |  |
| OTC112 | Cap for connection bend | € 1,05 |  |
| OBB130C | 500 pcs. package of 12 mm 6 MA screws with nuts | € 82,18 |  |
| OBB140C | 500 pcs. package of 40 mm 6 MA screws with nuts | € 137,28 |  |
| OPIF210 | Bracket for double sided lightboxes | € 31,07 |  |

ALUMINIUM PROFILES FOR LIGHTBOXES

PROFILES 80

Extruded aluminium profile for light boxes.
 Ideal for small single-sided light boxes.
 Profile size 80 mm total complete with profile 73 + 20x20 corner piece.
 Use sheets with a maximum thickness of 4 mm.
 Internal brackets can be used for 45° profile cuts, or corner pieces or curves (with end caps) for 90° profile cuts.





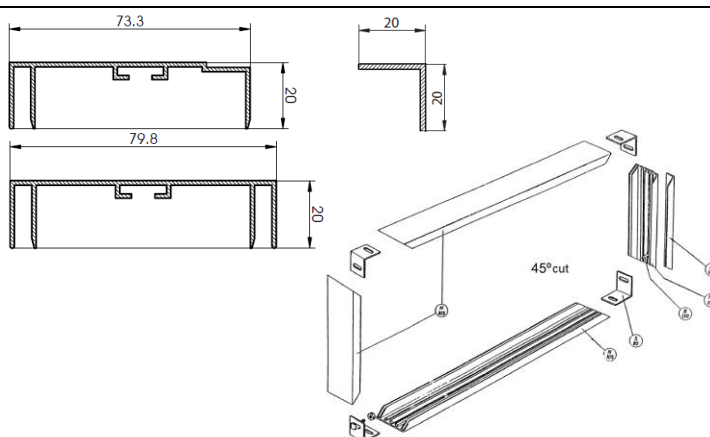

For NEON lighting systems, see Chapter 5 (NEON lighting).
 For LED modules and power supplies, see Chapter 6 (LED lighting).

Please note: to obtain the desired box dimensions when using FCUR curves or FANG corner pieces, it is necessary to reduce the length of the profiles by 100 mm (FCUR) and 40 mm (FANG).



| Code | Description | | | €/m | €/Pcs. |
|----------|-----------------------------|-----------|-----------------|---------|---------|
| | Type | Material | Colour | | |
| FPRA736 | Profile 73 - 6 m | Aluminium | Anodized Silver | € 10,73 | € 64,35 |
| FPRA806 | Profile 80 - 6 m | Aluminium | Anodized Silver | € 15,60 | € 93,60 |
| FPRA206 | Angular 20x20x1,5 - 6 m | Aluminium | Anodized Silver | € 4,95 | € 29,70 |
| FTUBETTO | Square tube 15x15x1,5 - 4 m | Aluminium | Mill Finish | € 5,46 | € 21,86 |

Customised cutting and anodised or painted profiles in other colours available on request.

| Accessories Code | Description | €/Pack. | Image |
|------------------|--|---------|---|
| FSQ | Zinc plated steel L bracket 25x45 | € 0,75 |  |
| FANG80 | Aluminium connection angle (NB - Subtract 40 mm from the length of the profile) | € 8,36 |  |
| FCUR80 | Aluminium connection bend (NB - Subtract 100 mm from the length of the profile) | € 11,95 |  |
| FTAP | Cap for connection angles | € 0,63 |  |
| FTAPC | Cap for connection bend | € 2,54 |  |
| FVIT15C | 500 pcs. package of 15 mm 6 MA screws | € 82,91 |  |
| FDADOC | 500 pcs. package of 6 MA hexagonal nuts | € 35,27 |  |

ALUMINIUM PROFILES FOR LIGHTBOXES



PROFILES 120

Extruded aluminium profile for light boxes.
 Ideal for small and medium-sized single-sided light boxes.
 Profile size 120 mm total complete with profile 113 + 20x20 corner piece.
 Use sheets with a maximum thickness of 4 mm.
 Internal brackets can be used for 45° profile cuts, or corner brackets or curves (with end caps) for 90° profile cuts.
 We recommend reinforcing the structure using an internal support tube.





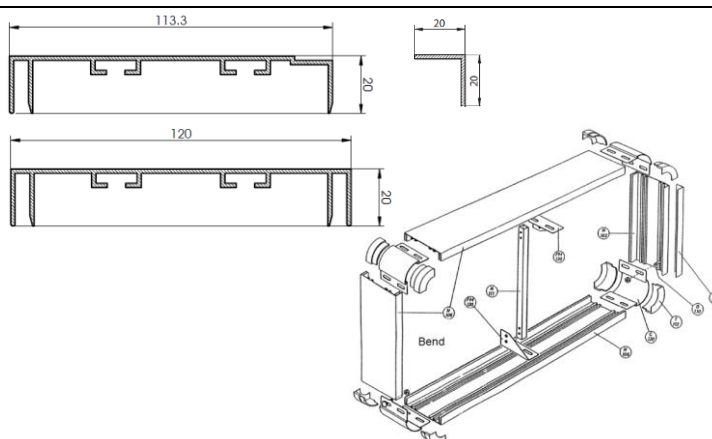

For NEON lighting systems, see Chapter 5 (NEON lighting).
 For LED modules and power supplies, see Chapter 6 (LED lighting).

Please note: to obtain the desired box dimensions when using FCUR curves or FANG corner pieces, it is necessary to reduce the length of the profiles by 100 mm (FCUR) and 40 mm (FANG).

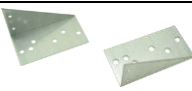

| Code | Description | | | €/m | €/Pcs. |
|----------|-----------------------------|-----------|-----------------|---------|----------|
| | Type | Material | Colour | | |
| FPRA1136 | Profile 113 - 6 m | Aluminium | Anodized Silver | € 17,90 | € 107,40 |
| FPRA1206 | Profile 120 - 6 m | Aluminium | Anodized Silver | € 19,53 | € 117,15 |
| FPRA206 | Angular 20x20x1,5 - 6 m | Aluminium | Anodized Silver | € 4,95 | € 29,70 |
| FTUBETTO | Square tube 15x15x1,5 - 4 m | Aluminium | Mill Finish | € 5,46 | € 21,86 |

Customised cutting and anodised or painted profiles in other colours available on request.

| Accessories Code | Description | €/Pack. | Image |
|------------------|--|---------|---|
| FSQ120 | Zinc plated steel L bracket | € 2,54 |  |
| FANG120 | Aluminium connection angle (NB - Subtract 40 mm from the length of the profile) | € 9,25 |  |
| FCUR120 | Aluminium connection bend (NB - Subtract 100 mm from the length of the profile) | € 13,44 |  |
| FSF120 | Zinc plated steel right or left | € 2,87 |  |
| FTAP | Cap for connection angles | € 0,63 |  |
| FTAPC | Cap for connection bend | € 2,54 |  |
| FVIT15C | 500 pcs. package of 6 MA screws | € 82,91 |  |
| FDADOC | 500 pcs. package of 6 MA hexagonal nuts | € 35,52 |  |

ALUMINIUM PROFILES FOR LIGHTBOXES



PROFILES 150

Extruded aluminium profile for light boxes.
 Ideal for medium and large single-sided and double-sided light boxes.
 Profile size 150 mm total complete with profile 143 + 20x20 corner piece.
 Use sheets with a maximum thickness of 4 mm.
 Internal brackets can be used for 45° profile cuts, or corner brackets or curves (with end caps) for 90° profile cuts.
 We recommend reinforcing the structure using an internal support tube.



For NEON lighting systems, see Chapter 5 (NEON lighting).
 For LED modules and power supplies, see Chapter 6 (LED lighting).

Please note: to obtain the desired box dimensions when using FCUR curves or FANG corner pieces, it is necessary to reduce the length of the profiles by 100 mm (FCUR) and 40 mm (FANG).



| Code | Description | | | €/m | €/Pcs. |
|----------|-----------------------------|-----------|-----------------|---------|----------|
| | Type | Material | Colour | | |
| FPRA1436 | Profile 143 - 6 m | Aluminium | Anodized Silver | € 19,78 | € 118,65 |
| FPRA1506 | Profile 150 - 6 m | Aluminium | Anodized Silver | € 21,90 | € 131,40 |
| FPRA206 | Angular 20x20x1,5 - 6 m | Aluminium | Anodized Silver | € 4,95 | € 29,70 |
| FTUBETTO | Square tube 15x15x1,5 - 4 m | Aluminium | Mill Finish | € 5,46 | € 21,86 |

Customised cutting and anodised or painted profiles in other colours available on request.

| Accessories Code | Description | €/Pack. | Image |
|------------------|--|---------|---|
| FSQ150 | Zinc plated steel L bracket | € 2,87 |  |
| FANG150 | Aluminium connection angle (NB - Subtract 40 mm from the length of the profile) | € 10,18 |  |
| FCUR150 | Aluminium connection bend (NB - Subtract 100 mm from the length of the profile) | € 14,93 |  |
| FSF150 | Zinc plated steel right or left | € 3,12 |  |
| FTAP | Cap for connection angles | € 0,63 |  |
| FTAPC | Cap for connection bend | € 2,54 |  |
| FVIT15C | 500 pcs. package of 6 MA screws | € 82,91 |  |
| FDADOC | 500 pcs. package of 6 MA hexagonal nuts | € 35,52 |  |

ALUMINIUM PROFILES FOR LIGHTBOXES



PROFILES 163

Extruded aluminium profile for light boxes.
 Ideal for medium and large single-sided and double-sided light boxes.
 Profile size 170 mm total complete with profile 163 + 20x20 corner piece.
 Use sheets with a maximum thickness of 4 mm.
 Internal brackets can be used for 45° profile cuts, or corner brackets or curves (with end caps) for 90° profile cuts.
 We recommend reinforcing the structure using an internal support tube.





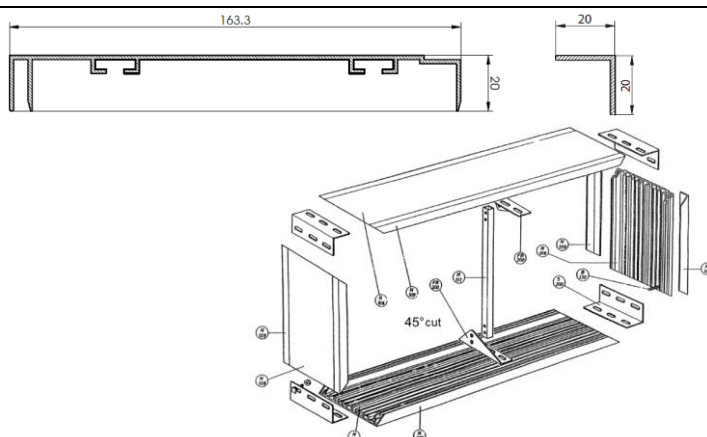

For NEON lighting systems, see Chapter 5 (NEON lighting).
 For LED modules and power supplies, see Chapter 6 (LED lighting).

Please note: to obtain the desired box dimensions when using FCUR curves or FANG corner pieces, it is necessary to reduce the length of the profiles by 100 mm (FCUR) and 40 mm (FANG).



| Code | Description | | | €/m | €/Pcs. |
|----------|-----------------------------|-----------|-----------------|---------|----------|
| | Type | Material | Colour | | |
| FPRA1636 | Profile 163 - 6 m | Aluminium | Anodized Silver | € 19,33 | € 115,95 |
| FPRA206 | Angular 20x20x1,5 - 6 m | Aluminium | Anodized Silver | € 4,95 | € 29,70 |
| FTUBETTO | Square tube 15x15x1,5 - 4 m | Aluminium | Mill Finish | € 5,46 | € 21,86 |

Customised cutting and anodised or painted profiles in other colours available on request.

| Accessories Code | Description | €/Pack. | Image |
|------------------|--|---------|---|
| FSQ150 | Zinc plated steel L bracket | € 2,87 |  |
| FANG170 | Aluminium connection angle (NB - Subtract 40 mm from the length of the profile) | € 10,76 |  |
| FCUR170 | Aluminium connection bend (NB - Subtract 100 mm from the length of the profile) | € 16,12 |  |
| FSF170 | Zinc plated steel right or left | € 3,12 |  |
| FTAP | Cap for connection angles | € 0,63 |  |
| FTAPC | Cap for connection bend | € 2,54 |  |
| FVIT15C | 500 pcs. package of 6 MA screws | € 82,91 |  |
| FDADOC | 500 pcs. package of 6 MA hexagonal nuts | € 35,52 |  |

ALUMINIUM PROFILES FOR LIGHTBOXES



PROFILES 186

Profile for single or double sided lightboxes with rigid front and back panels up to 4 mm thick.

Two 25x25 mm L profile are fixed with screws onto the 186 mm profile to obtain a side that could be open to let the front panel slide out.

To ease mounting and internal inspection it is necessary that at least one side of the lightbox is made with these profiles, the other sides are made with the 200 mm profile. The FSQ corners are used both to join mitred corners and to mount reinforcements made with 15x15 mm square tube.

The sides of front and back panels must be 7 mm shorter than the overall dimensions of the lightbox to accommodate thermal expansion.

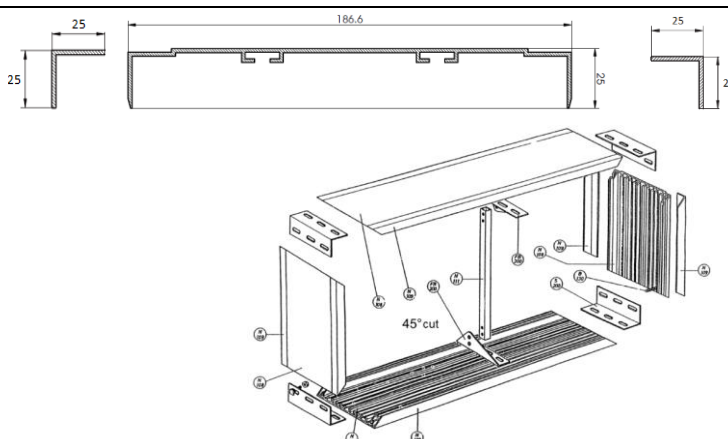

For NEON lighting see Ch. 5 (NEON lighting).

For modules and power supplies see Ch. 6 (LED lighting).



| Code | Description | | | €/m | €/Pcs. |
|-----------|-----------------------------|-----------|-----------------|---------|----------|
| | Type | Material | Colour | | |
| FPRA1866* | Profile 186 - 6 m | Aluminium | Anodized Silver | € 30,63 | € 183,75 |
| FPRA256 | Angular 25x25x1,5 - 6 m | Aluminium | Anodized Silver | € 5,73 | € 34,38 |
| FTUBETTO | Square tube 15x15x1,5 - 4 m | Aluminium | Mill Finish | € 5,46 | € 21,86 |

Customised cutting and anodised or painted profiles in other colours available on request.
 * On this model we don't make any 45° cut

| Accessories Code | Description | €/Pack. | Image |
|------------------|---|---------|---|
| FSQ150 | Zinc plated steel L bracket | € 2,87 |  |
| FVIT15C | 500 pcs. package of 6 MA screws | € 82,91 |  |
| FDADOC | 500 pcs. package of 6 MA hexagonal nuts | € 35,52 |  |

PROFILES FOR SINGLE SIDE TEXTILE LIGHTBOXES





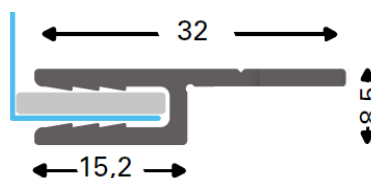

T-FLEX® 9/1 RETROFIT

Aluminium profile for single side frames with keder-edged tensioned fabrics.
 To be fixed on pre-existing wood, metal or wall structures.
 Size is limited only by the support structure.
 No corner connectors are needed, the profile is screwed or riveted to the desired part.

For LED modules and power supplies see Ch. 6 (LED lighting).



| Code | Description | | | €/m | €/Pcs. |
|--|-----------------------------------|-----------|-----------------|--------|---------|
| | Type | Material | Colour | | |
| ED109PF010 | Profile T-Flex 9/1 Single - 6,1 m | Aluminium | Anodized Silver | € 7,22 | € 44,04 |
| Cutting and coloured painting/anodizing on demand | | | | | |

| Accessories Code | Description | €/Pack. | Image |
|------------------|---|----------|---|
| ED100PF010 | 3x14 transparent blue PVC flat keder 200 m reel | € 79,38 |  |
| ED100PF030 | 3x14 transparent blue PVC flat keder 200 m reel | € 79,38 |  |
| ED100PF020 | 7x13 grey PVC hammer keder 100 m reel | € 207,90 |  |
| EOMFNASTRO | 2,8x13,5 transparent PVC flat keder 100 m reel | € 91,80 |  |

PROFILES FOR SINGLE SIDE TEXTILE LIGHTBOXES



ECOPLUS SIMPLEX

Aluminium profile for single side non-illuminated frames with keder-edged tensioned fabrics.
 Suitable for wall mounted, small-to-medium format frames.
 Corner connectors come complete with screws.



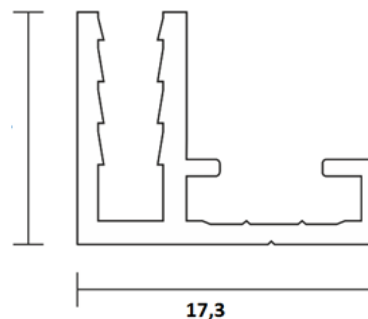



16,2





17,3

| Code | Description | | | €/m | €/Pcs. |
|-----------|---------------------------------|-----------|-----------------|--------|---------|
| | Type | Material | Colour | | |
| EEPLUS046 | Profile Simplex Single - 6,1 m | Aluminium | Anodized Silver | € 4,76 | € 29,04 |
| EEPLUS041 | Profile Simplex Single - 3,05 m | Aluminium | Anodized Silver | € 4,76 | € 14,52 |





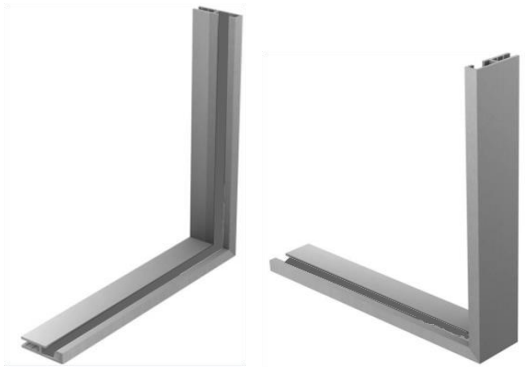

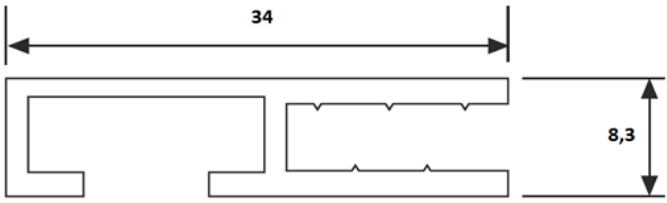
Cutting and coloured painting/anodizing on demand

| Accessories Code | Description | €/Pack. | Image |
|------------------|---|----------|---|
| EOSNCON25F | 10 pcs. package of lateral L connectors | € 6,72 |  |
| EEPLUSCONLS | Linear connector | € 1,90 |  |
| ED100PF010 | 3x14 transparent blue PVC flat keder 200 m reel | € 79,38 |  |
| ED100PF030 | 3x14 transparent blue PVC flat keder 200 m reel | € 79,38 |  |
| ED100PF020 | 7x13 grey PVC hammer keder 100 m reel | € 207,90 |  |
| EOMFNASTRO | 2,8x13,5 transparent PVC flat keder 100 m reel | € 91,80 |  |

PROFILES FOR SINGLE SIDE TEXTILE LIGHTBOXES

| | |
|--|---|
|  |  |
| <p>ECOPLUS ACE</p> <p>Aluminium profile for single side non-illuminated frames with keder-edged tensioned fabrics. Suitable for wall mounted small-to-medium format frames, could also be mounted on the edge of niches in walls and furnitures. The metal corner connectors are available also in a version complete with plate for mounting. Corner connectors come complete with screws.</p> <p>For LED modules and power supplies see Ch. 6 (LED lighting).</p> |  |

| Code | Description | | | €/m | €/Pcs. |
|--|-----------------------------|-----------|-----------------|--------|---------|
| | Type | Material | Colour | | |
| EOMFBPROF6 | Profile Ace Single - 6,1 m | Aluminium | Anodized Silver | € 7,25 | € 44,20 |
| EOMFBPROF | Profile Ace Single - 3,05 m | Aluminium | Anodized Silver | € 7,25 | € 22,10 |
| Cutting and coloured painting/anodizing on demand | | | | | |

| Accessories Code | Description | €/Pack. | Image |
|------------------|--|----------|---|
| EOMFCONQUA | 10 pcs. package of square angular connectors for 45° cut | € 29,76 |  |
| EEPLUSCON100 | 10 pcs. package of internal L connectors | € 27,70 |  |
| ED100PF010 | 3x14 transparent blue PVC flat keder 200 m reel | € 79,38 |  |
| ED100PF030 | 3x14 transparent blue PVC flat keder 200 m reel | € 79,38 |  |
| ED100PF020 | 7x13 grey PVC hammer keder 100 m reel | € 207,90 |  |
| EOMFNASTRO | 2,8x13,5 transparent PVC flat keder 100 m reel | € 91,80 |  |

PROFILES FOR SINGLE SIDE TEXTILE FRAMES AND STRUCTURES

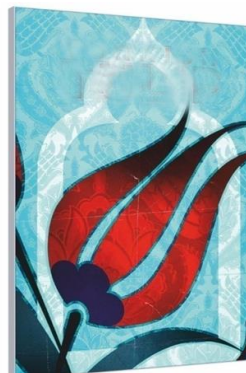

ECOPLUS DAME

Aluminium profile for single side non-illuminated frames with keder-edged tensioned fabrics.

Suitable for wall mounted, medium-to-large format frames.

In case of mitred 45° cut it can accommodate up to 3 metal connectors per corner, available also with plate for wall mounting.

Plastic corner connectors for 90° cut.

The use of reinforcement profiles is recommended for sides longer than 2 m





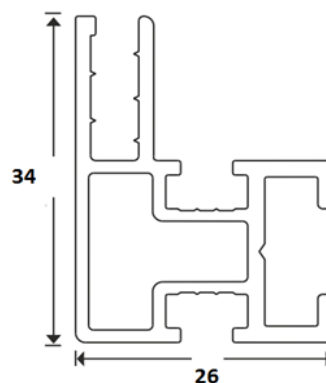





Corner connectors come complete with screws.

For LED modules and power supplies see Ch. 6 (LED lighting).



| Code | Description | | | €/m | €/Pcs. |
|------------|------------------------------|-----------|-----------------|---------|---------|
| | Type | Material | Colour | | |
| EOMFGPROF6 | Profile Dame Single - 6,1 m | Aluminium | Anodized Silver | € 11,50 | € 70,16 |
| EOMFGPROF | Profile Dame Single - 3,05 m | Aluminium | Anodized Silver | € 11,50 | € 35,08 |

Cutting and coloured painting/anodizing on demand

| Accessories Code | Description | €/Pack. | Image |
|------------------|---|----------|---|
| EOMFCONQUA | 10 pcs. package of square angular connectors for 45° cut | € 29,76 |  |
| EOSNCON25F | 10 pcs. package of lateral L connectors | € 6,72 |  |
| EEPLUSCON100 | 10 pcs. package of internal L connectors | € 27,70 |  |
| EOMFGANG | 10 pcs. package of external plastic square angular connectors | € 12,80 |  |
| EOMFH | 3,00 m of 45x16 H shaped support profiles | € 33,30 |  |
| EOMFHCON | 10 pcs. package of connectors for H profiles | € 34,10 |  |
| ED100PF010 | 3x14 transparent blue PVC flat keder 200 m reel | € 79,38 |  |
| ED100PF030 | 3x14 transparent blue PVC flat keder 200 m reel | € 79,38 |  |
| ED100PF020 | 7x13 grey PVC hammer keder 100 m reel | € 207,90 |  |
| EOMFNASTRO | 2,8x13,5 transparent PVC flat keder 100 m reel | € 91,80 |  |

PROFILES FOR DOUBLE SIDE TEXTILE FRAMES AND STRUCTURES



ECOPLUS KING

Aluminium profile for double side non-illuminated frames with keder-edged tensioned fabrics.

Suitable for small-to-medium size hanging or self-standing structures with feet.

In case of mitred 45° cut it can accommodate up to 3 metal connectors per corner.

Plastic corner connectors for 90° cut.

The use of reinforcement profiles is recommended for sides longer than 2 m





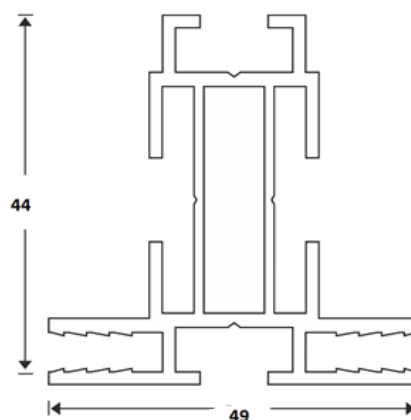





Corner connectors come complete with screws.

For LED modules and power supplies see Ch. 6 (LED lighting).



| Code | Description | | | €/m | €/Pcs. |
|------------|------------------------------|-----------|-----------------|---------|----------|
| | Type | Material | Colour | | |
| EOMFOPROF6 | Profile King Double - 6,1 m | Aluminium | Anodized Silver | € 20,07 | € 122,44 |
| EOMFOPROF | Profile King Double - 3,05 m | Aluminium | Anodized Silver | € 20,07 | € 61,22 |

Cutting and coloured painting/anodizing on demand

| Accessories Code | Description | €/Pack. | Image |
|------------------|---|----------|---|
| EOMFCONCUN | 8 pcs. package of lateral L connectors for 45° cut | € 30,16 |  |
| EEPLUSCON100 | 10 pcs. package of internal L connectors | € 27,70 |  |
| EOMFOANG | 4 pcs. package of lateral L external plastic connectors | € 12,80 |  |
| EOMFH | 3,05 m of 45x16 H shaped support profiles | € 33,30 |  |
| EOMFHCON | 10 pcs. package of connectors for H profiles | € 34,10 |  |
| EOMFOFF | Iron base 100x600 with connector | € 49,60 |  |
| EOMFKIT | 2 pcs. package of standard suspension kit | € 21,24 |  |
| ED100PF010 | 3x14 transparent blue PVC flat keder 200 m reel | € 79,38 |  |
| ED100PF020 | 7x13 grey PVC hammer keder 100 m reel | € 207,90 |  |
| EOMFNASTRO | 2,8x13,5 transparent PVC flat keder 100 m reel | € 91,80 |  |

PROFILES FOR DOUBLE SIDE TEXTILE FRAMES AND STRUCTURES



T-FLEX 46/2 BASIC

Aluminium profile for double side non-illuminated frames with keder-edged tensioned fabrics.

Suitable for small-to-medium size hanging or self-standing structures with feet.

In case of mitred 45° cut it can accommodate up to 2 metal connectors per corner.

Plastic corner connectors for 90° cut.







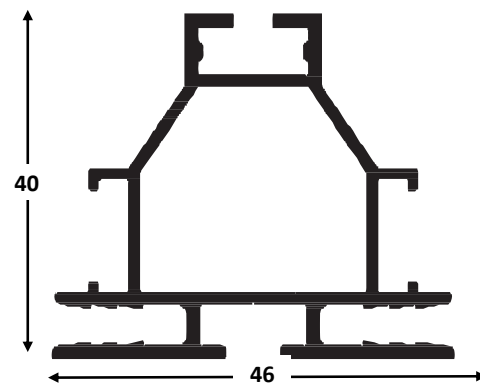



The use of reinforcement profiles is recommended for sides longer than 2 m

Corner connectors come complete with screws.

For LED modules and power supplies see Ch. 6 (LED lighting).



| Code | Description | | | €/m | €/Pcs. |
|--|-----------------------------|-----------|-----------------|---------|----------|
| | Type | Material | Colour | | |
| ED146PF010 | Profilo T-Flex 46/2 - 6,1 m | Aluminium | Anodized Silver | € 18,25 | € 111,33 |
| Cutting and coloured painting/anodizing on demand | | | | | |

| Accessories Code | Description | €/pc. | Image |
|------------------|--|----------|---|
| ED117PF016 | Steel L-angle connector for T-Flex 17 and 46 | € 1,11 |  |
| ED146PF016 | Straight connector 100 mm ² | € 1,01 |  |
| ED196PF015 | Foot B steel 400x60 RAL 9006 | € 34,59 |  |
| ED400PC015 | Reinforcement profile anodised 6.10 m | € 13,46 |  |
| ED146PF017 | Connector for H-profiles | € 3,17 |  |
| ED146PF018 | Standard suspension kit pcs. 2 | € 17,24 |  |
| ED100PF010 | PVC blue grommet 3x14 for fabric 200 m | € 79,38 |  |
| ED100PF030 | 3x14 transparent blue PVC flat keder 200 m reel | € 79,38 |  |
| ED100PF020 | PVC grommet grey 7x13 seamless 100 m | € 207,90 |  |
| EOMFNASTRO | Transparent PVC perimeter trim 2.8x13.5 for fabric 100 m | € 91,80 |  |

PROFILES FOR DOUBLE SIDE TEXTILE FRAMES AND STRUCTURES



ECOPLUS 80

Aluminium profile for double side non-illuminated frames with keder-edged tensioned fabrics.

Suitable for medium-to-large size hanging or self-standing structures with feet.

Mitred 45° cut is necessary.

It can accommodate up to 4 metal connectors per corner.

The use of reinforcement profiles is recommended for sides longer than 3 m





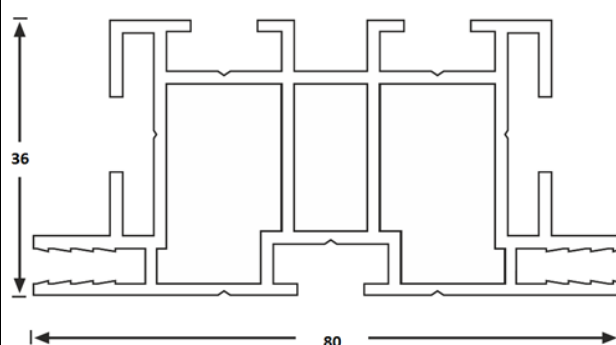





Corner connectors come complete with screws.

For LED modules and power supplies see Ch. 6 (LED lighting).



| Code | Description | | | €/m | €/Pcs. |
|-------------|----------------------------|-----------|-----------------|---------|----------|
| | Type | Material | Colour | | |
| EEPLUS00806 | Profile 80 Double - 6,1 m | Aluminium | Anodized Silver | € 35,12 | € 214,24 |
| EEPLUS0080 | Profile 80 Double - 3,05 m | Aluminium | Anodized Silver | € 35,12 | € 107,12 |

Cutting and coloured painting/anodizing on demand

| Accessories Code | Description | €/Pack. | Image |
|------------------|--|----------|---|
| EOMFCONCUN | 8 pcs. package of lateral L connectors for 45° cut | € 30,16 |  |
| EEPLUSCON100 | 10 pcs. package of internal L connectors | € 27,70 |  |
| EOMFH | 3,00 m of 45x16 H shaped support profiles | € 33,30 |  |
| EOMFHCON | 10 pcs. package of connectors for H profiles | € 34,10 |  |
| EOMFOFF | Iron base 100x600 with connector | € 49,60 |  |
| EOMFKIT | 2 pcs. package of standard suspension kit | € 21,24 |  |
| ED100PF010 | 3x14 transparent blue PVC flat keder 200 m reel | € 79,38 |  |
| ED100PF030 | 3x14 transparent blue PVC flat keder 200 m reel | € 79,38 |  |
| ED100PF020 | 7x13 grey PVC hammer keder 100 m reel | € 207,90 |  |
| EOMFNASTRO | 2,8x13,5 transparent PVC flat keder 100 m reel | € 91,80 |  |

PROFILES FOR SINGLE SIDE TEXTILE LIGHTBOXES



ECOPLUS 55

Aluminium profile for single side illuminated frames with keder-edged tensioned fabrics.

Suitable for thin, small-to medium format wall-mounted lightboxes.

Panels up to 3 mm thick can be screwed or riveted on the backside edge.





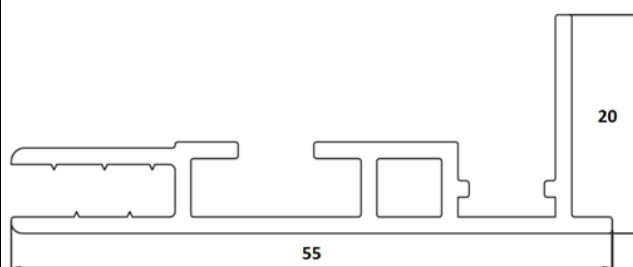

Corner connectors come complete with grub screws.

For LED modules and power supplies see Ch. 6 (LED lighting).



| Code | Description | | | €/m | €/Pcs. |
|------------|---------------------------|-----------|-----------------|---------|---------|
| | Type | Material | Colour | | |
| EEPLUS055 | Profile 55 Single - 6,1 m | Aluminium | Anodized Silver | € 11,72 | € 71,52 |
| EEPLUS055B | Profile 55 Single - 6,1 m | Aluminium | Matt white | € 12,89 | € 78,60 |
| EEPLUS055N | Profile 55 Single - 6,1 m | Aluminium | Matt black | € 12,89 | € 78,60 |

Cutting and coloured painting/anodizing on demand

| Accessories Code | Description | €/Pack. | Image |
|------------------|---|----------|---|
| EEPLUSCON100 | 10 pcs. package of internal L connectors | € 27,70 |  |
| EEPLUSCONL | Linear connector | € 2,50 |  |
| ED200AA000 | Aluminium adhesive joining strip 45x2000 | € 12,98 |  |
| ED100PF010 | 3x14 transparent blue PVC flat keder 200 m reel | € 79,38 |  |
| ED100PF030 | 3x14 transparent blue PVC flat keder 200 m reel | € 79,38 |  |
| ED100PF020 | 7x13 grey PVC hammer keder 100 m reel | € 207,90 |  |
| EOMFNASTRO | 2,8x13,5 transparent PVC flat keder 100 m reel | € 91,80 |  |

PROFILES FOR SINGLE SIDE TEXTILE LIGHTBOXES

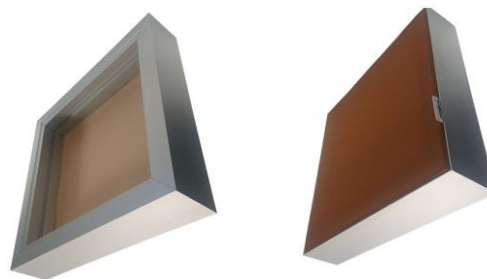
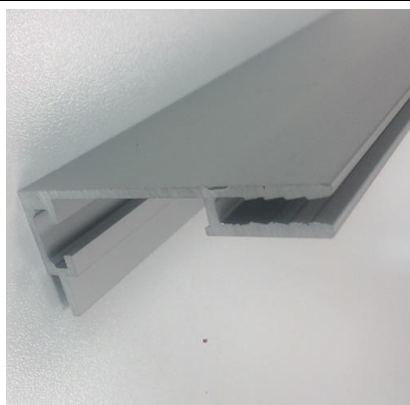

ECOPLUS MAXI

Aluminium profile for single side illuminated frames with keder-edged tensioned fabrics.

Suitable for thin, small-to medium format wall-mounted lightboxes.





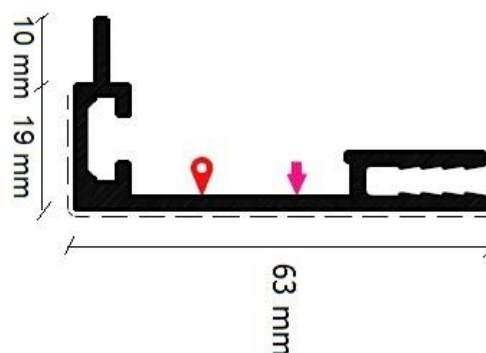

Panels up to 3 mm thick can be screwed or riveted on the backside edge.

Corner connectors come complete with grub screws.

For LED modules and power supplies see Ch. 6 (LED lighting).



| Code | Description | | | €/m | €/Pcs. |
|---|------------------------------|-----------|-----------------|---------|---------|
| | Type | Material | Colour | | |
| EEPLUS063 | Profile Maxi Single - 6,05 m | Aluminium | Anodized Silver | € 14,56 | € 88,08 |
| Cutting and coloured painting/anodizing on demand | | | | | |

| Accessories Code | Description | €/each | Image |
|------------------|---|----------|---|
| EEPLUSCON | Corner connector for EcoPlus Maxi Corner | € 1,41 |  |
| EEPLUSCONLM | Linear connector Conf. 10pcs | € 9,79 |  |
| ED200AA000 | Aluminium adhesive joining strip 45x2000 | € 11,91 |  |
| ED100PF010 | 3x14 transparent blue PVC flat keder 200 m reel | € 79,38 |  |
| ED100PF030 | 3x14 transparent blue PVC flat keder 200 m reel | € 79,38 |  |
| ED100PF020 | 7x13 grey PVC hammer keder 100 m reel | € 207,90 |  |
| EOMFNASTRO | 2,8x13,5 transparent PVC flat keder 100 m reel | € 91,80 |  |

PROFILES FOR SINGLE SIDE TEXTILE LIGHTBOXES



T-FLEX® 100

Aluminium profile for single side illuminated frames with keder-edged tensioned fabrics.

For medium-to-large wall-mounted or self-standing frames with feet.

The double channel for the keder allows the application of an inner white textile to improve diffusion and to hide the electrical parts during the printed textile changeover. Accepts 2 mm thick backside panels, it is suggested to fix them to the profile by means of the special backpanel support.

Corner connectors come complete with bolts and nuts.

For LED modules and power supplies see Ch. 6 (LED lighting).

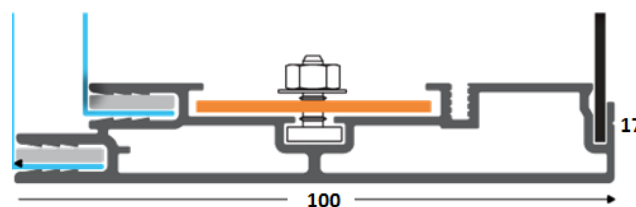

| Code | Description | | | €/m | €/Pcs. |
|------------|-----------------------------------|-----------|-----------------|---------|----------|
| | Type | Material | Colour | | |
| ED110PF010 | Profile T-Flex 100 Single - 6,1 m | Aluminium | Anodized Silver | € 25,52 | € 155,64 |

Cutting and coloured painting/anodizing on demand

| Accessories Code | Description | €/each | Image |
|------------------|---|----------|---|
| ED110PF015 | T-Flex 100 backpanel support 40 mm | € 4,35 |  |
| ED110PF016 | Corner connector FastFix | € 3,36 |  |
| ED110PF017 | Straight connector FastFix | € 3,84 |  |
| ED196PF015 | Foot B steel 400x60 RAL 9006 | € 34,59 |  |
| ED196PF016 | Mounting plate for foot | € 2,23 |  |
| LOJ06105 | M5x20 screws, pack of 4 | € 2,40 |  |
| ED200AA000 | Aluminium adhesive joining strip 45x2000 | € 12,98 |  |
| ED100PF010 | 3x14 transparent blue PVC flat keder 200 m reel | € 79,38 |  |
| ED100PF030 | 3x14 transparent blue PVC flat keder 200 m reel | € 79,38 |  |
| ED100PF020 | 7x13 grey PVC hammer keder 100 m reel | € 207,90 |  |
| EOMFNASTRO | 2,8x13,5 transparent PVC flat keder 100 m reel | € 91,80 |  |

PROFILES FOR SINGLE SIDE TEXTILE LIGHTBOXES

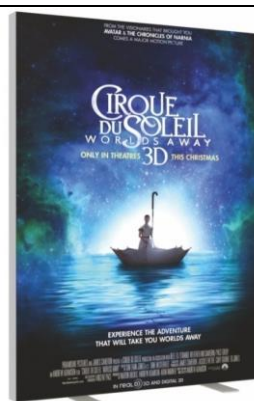

ECOPLUS 110

ON DEMAND

Profile for single side illuminated frames with keder-edged tensioned fabrics.

For medium-to-large wall-mounted or self-standing frames.

The double channel for the keder allows the application of an inner white textile to improve diffusion and to hide the electrical parts during the printed textile changeover.

Accepts 2 mm thick backside panels, it is suggested to screw or rivet them to the backside edge of the profile.

The backside channel for the keder permits the use of a blackout textile as rear panel.

The use of reinforcement profiles is recommended for sides longer than 3 m





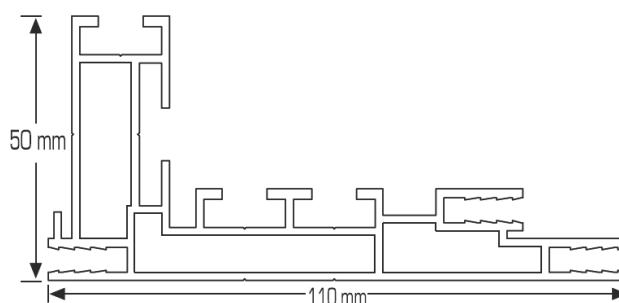





Corner connectors come complete with bolts and nuts.

For LED modules and power supplies see Ch. 6 (LED lighting).



| Code | Description | | | €/m | €/Pcs. |
|-------------|-----------------------------|-----------|-----------------|---------|----------|
| | Type | Material | Colour | | |
| EEPLUS01106 | Profile 110 Single - 6,1 m | Aluminium | Anodized Silver | € 37,70 | € 230,00 |
| EEPLUS0110 | Profile 110 Single - 3,05 m | Aluminium | Anodized Silver | € 37,70 | € 115,00 |

Cutting and colored painting/anodizing on demand

| Accessories Code | Description | €/Pack. | Image |
|------------------|--|----------|---|
| EEPLUSCON100 | 10 pcs. package of internal L connectors | € 27,70 |  |
| EOMFCONCUN | 8 pcs. package of lateral L connectors for 45° cut | € 30,16 |  |
| EOMFH | 3,00 m of 45x16 H shaped support profiles | € 33,30 |  |
| EOMFHCON | 10 pcs. package of connectors for H profiles | € 34,10 |  |
| EOMFOFF | Iron base 100x600 with connector (adaptable by drilling the profile) | € 49,60 |  |
| ED200AA000 | Aluminium adhesive joining strip 45x2000 | € 11,91 |  |
| ED100PF010 | 3x14 transparent blue PVC flat keder 200 m reel | € 79,38 |  |
| ED100PF030 | 3x14 transparent blue PVC flat keder 200 m reel | € 79,38 |  |
| ED100PF020 | 7x13 grey PVC hammer keder 100 m reel | € 207,90 |  |
| EOMFNASTRO | 2,8x13,5 transparent PVC flat keder 100 m reel | € 91,80 |  |

PROFILES FOR SINGLE SIDE TEXTILE LIGHTBOXES



T-FLEX® 150

Aluminium profile for single side illuminated frames with keder-edged tensioned fabrics.

For medium-to-large wall-mounted or self-standing frames with feet.

The double channel for the keder allows the application of an inner white textile to improve diffusion and to hide the electrical parts during the printed textile changeover. Accepts 2 mm thick backside panels, it is suggested to fix them to the profile by means of the special backpanel support.

The use of reinforcement profiles is recommended for sides longer than 3 m

Corner connectors come complete with bolts and nuts.

For LED modules and power supplies see Ch. 6 (LED lighting).

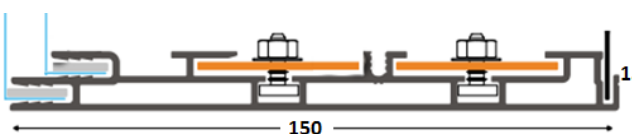

| Code | Description | | | €/m | €/Pcs. |
|------------|-----------------------------------|-----------|-----------------|---------|----------|
| | Type | Material | Colour | | |
| ED115PF010 | Profile T-Flex 150 Single - 6,1 m | Aluminium | Anodized Silver | € 35,13 | € 214,31 |

Cutting and coloured painting/anodizing on demand

| Accessories Code | Description | €/each | Image |
|------------------|---|----------|---|
| ED185PF015 | T-Flex 150 backpanel support 40 mm | € 4,26 |  |
| ED110PF016 | Corner connector FastFix | € 3,36 |  |
| ED110PF017 | Straight connector FastFix | € 3,84 |  |
| ED196PF015 | Foot B steel 400x60 RAL 9006 | € 34,59 |  |
| ED196PF016 | Mounting plate for foot | € 2,23 |  |
| LOJ06105 | M5x20 screws, pack of 4 | € 2,40 |  |
| ED115PF016 | Assembly bracket for 40x20x2 reinforcements 35 mm | € 3,97 |  |
| FTUB4020 | Rectangular tube 40x20x2 mill 6 m | € 50,25 |  |
| ED200AA000 | Aluminium joining strip 45x2000 | € 12,98 |  |
| ED100PF030 | 3x14 transparent blue PVC flat keder 200 m reel | € 79,38 |  |
| ED100PF010 | 3x14 transparent blue PVC flat keder 200 m reel | € 79,38 |  |
| ED100PF020 | 7x13 grey PVC hammer keder 100 m reel | € 207,90 |  |
| EOMFNASTRO | 2,8x13,5 transparent PVC flat keder 100 m reel | € 91,80 |  |

PROFILES FOR DOUBLE SIDE TEXTILE LIGHTBOXES



T-FLEX® 96/2

Aluminium profile for double side illuminated frames with keder-edged tensioned fabrics.
 For small-to-medium wall-mounted, suspended or self-standing frames with feet.
 The double channel for the keder allows the application of an inner white textile to improve diffusion and to hide the electrical parts during the printed textile changeover.
 The backpanel support of T-flex 100 can be used to fix T-flex 96/2 to walls.
 The use of reinforcement profiles is recommended for sides longer than 1,5 m
 Corner connectors come complete with bolts and nuts.

For LED modules and power supplies see Ch. 6 (LED lighting).

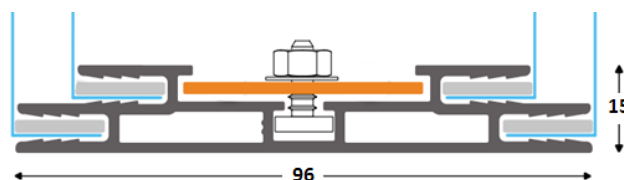

| Code | Description | | | €/m | €/Pcs. |
|------------|------------------------------------|-----------|-----------------|---------|----------|
| | Type | Material | Colour | | |
| ED196PF010 | Profile T-Flex 96/2 Double - 6,1 m | Aluminium | Anodized Silver | € 24,78 | € 151,16 |

Cutting and coloured painting/anodizing on demand

| Accessories Code | Description | €/each | Image |
|------------------|--|----------|---|
| ED110PF015 | T-Flex 100 backpanel support 40 mm (to be used for wall-mounting) | € 4,35 |  |
| ED110PF016 | Corner connector FastFix | € 3,36 |  |
| ED110PF017 | Straight connector FastFix | € 3,84 |  |
| ED196PF015 | Foot B steel 400x60 RAL 9006 | € 34,59 |  |
| ED185PF020 | Support bracket 25 mm with holes incl. 2 x hammerhead-bolts/nuts, for 30x30x2 reinforcements | € 3,99 |  |
| ED196PF016 | T-Flex mounting plate foot | € 2,23 |  |
| LOJ06105 | M5x20 screws, pack of 4 | € 2,40 |  |
| ED196PF017 | Reinforcement square tube 30x30x2 RAL 9016, 6 m | € 10,61 |  |
| ED100PF010 | 3x14 transparent blue PVC flat keder 200 m reel | € 79,38 |  |
| ED100PF030 | 3x14 transparent blue PVC flat keder 200 m reel | € 79,38 |  |
| ED100PF020 | 7x13 grey PVC hammer keder 100 m reel | € 207,90 |  |
| EOMFNASTRO | 2,8x13,5 transparent PVC flat keder 100 m reel | € 91,80 |  |

PROFILES FOR DOUBLE SIDE TEXTILE LIGHTBOXES

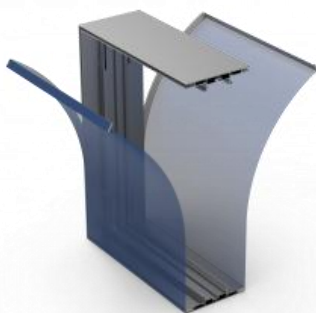

T-FLEX® 120/2

Aluminium profile for double side illuminated frames with keder-edged tensioned fabrics.
 For small-to-medium wall-mounted, suspended or self-standing frames with feet.
 The double channel for the keder allows the application of an inner white textile to improve diffusion and to hide the electrical parts during the printed textile changeover.
 The use of reinforcement profiles is recommended for sides longer than 1,5 m
 Corner connectors come complete with bolts and nuts.

For LED modules and power supplies see Ch. 6 (LED lighting).

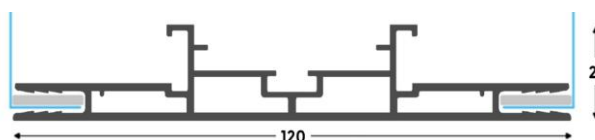

| Code | Description | | | €/m | €/Pcs. |
|---|------------------------------------|-----------|-----------------|---------|----------|
| | Type | Material | Colour | | |
| ED120PF010 | Profile T-Flex 96/2 Double - 6,1 m | Aluminium | Anodized Silver | € 27,41 | € 167,17 |
| Cutting and coloured painting/anodizing on demand | | | | | |

| Accessories Code | Description | €/each | Image |
|------------------|--|----------|---|
| ED117PF016 | Steel L angle T-Flex17 connector | € 1,11 |  |
| ED110PF016 | Corner connector FastFix | € 3,36 |  |
| ED110PF017 | Straight connector FastFix | € 3,84 |  |
| ED196PF015 | Foot B steel 400x60 RAL 9006 | € 34,59 |  |
| ED196PF016 | Mounting plate for foot | € 2,23 |  |
| LOJ06106 | M5x20 screws, pack of 4 | € 2,40 |  |
| ED185PF020 | Support bracket 25 mm with holes incl. 2 x hammerhead-bolts/nuts, for 30x30x2 reinforcements | € 3,99 |  |
| ED196PF017 | Reinforcement square tube 30x30x2 RAL 9016, 6 m | € 10,61 |  |
| ED100PF010 | 3x14 transparent blue PVC flat keder 200 m reel | € 79,38 |  |
| ED100PF030 | 3x14 transparent blue PVC flat keder 200 m reel | € 79,38 |  |
| ED100PF020 | 7x13 grey PVC hammer keder 100 m reel | € 207,90 |  |
| EOMFNASTRO | 2,8x13,5 transparent PVC flat keder 100 m reel | € 91,80 |  |

PROFILES FOR DOUBLE SIDE TEXTILE LIGHTBOXES



ECOPLUS 120/2





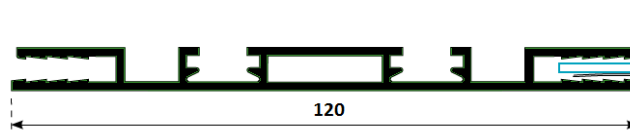





Aluminium profile for double side luminous frames with keder-edged tensioned fabrics.
 For small-to-medium suspended or self-standing frames.
 Corner connectors come complete with grub screws.
 The use of reinforcement profiles is recommended for sides longer than 1,5 m .

For LED modules and power supplies see Ch. 6 (LED lighting).



| Code | Description | | | €/m | €/Pcs. |
|-------------|------------------------------|-----------|-----------------|---------|----------|
| | Type | Material | Colour | | |
| EEPLUS01206 | Profile 120/2 Double - 6,1 m | Aluminium | Anodized Silver | € 26,20 | € 159,82 |

Cutting and coloured painting/anodizing on demand

| Accessories Code | Description | €/Pack. | Image |
|------------------|---|---------------|---|
| EEPLUSCON120 | Aluminium bracket | € 4,20 |  |
| ED185PF020 | Support bracket 25 mm with holes incl. for 30x30x2 reinforcements (to be fixed with FVIT15C screws) | € 3,99 |  |
| ED196PF017 | Reinforcement square tube 30x30x2 RAL 9016, 6 m | € 10,61 |  |
| FVIT15C | 500 pcs. package of 15 mm 6 MA screws | see page 4.12 |  |
| FDADOC | 500 pcs. package of 6 MA hexagonal nuts | € 20,99 |  |
| EOMFKIT | 2 pcs. package of standard suspension kit | € 21,24 |  |
| ED100PF010 | 3x14 transparent blue PVC flat keder 200 m reel | € 79,38 |  |
| ED100PF030 | 3x14 transparent blue PVC flat keder 200 m reel | € 79,38 |  |
| ED100PF020 | 7x13 grey PVC hammer keder 100 m reel | € 207,90 |  |
| EOMFNASTRO | 2,8x13,5 transparent PVC flat keder 100 m reel | € 91,80 |  |

PROFILES FOR DOUBLE SIDE TEXTILE LIGHTBOXES



ECOPLUS 160

ON DEMAND

Aluminium profile for double side luminous frames with keder-edged tensioned fabrics.

For medium-to-large wall-mounted, suspended or self-standing frames with feet.





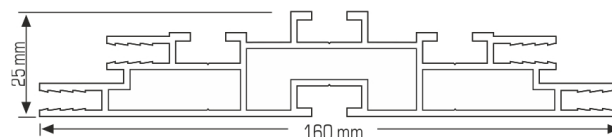



The double channel for the keder allows the application of an inner white textile to improve diffusion and to hide the electrical parts during the printed textile changeover. The use of reinforcement profiles is recommended for sides longer than 2 m. Corner connectors come complete with grub screws.

For LED modules and power supplies see Ch. 6 (LED lighting).



| Code | Description | | | €/m | €/Pcs. |
|-------------|-----------------------------|-----------|-----------------|---------|----------|
| | Type | Material | Colour | | |
| EEPLUS01606 | Profile 160 Double - 6,1 m | Aluminium | Anodized silver | € 39,64 | € 241,80 |
| EEPLUS0160 | Profile 160 Double - 3,05 m | Aluminium | Anodized silver | € 39,64 | € 120,90 |

Cutting and coloured painting/anodizing on demand

| Accessories Code | Description | €/Pack. | Image |
|------------------|---|----------|---|
| EEPLUSCON100 | 10 pcs. package of internal L connectors | € 27,70 |  |
| EOMFH | 3,00 m of 45x16 H shaped support profiles | € 33,30 |  |
| EOMFHCON | 10 pcs. package of connectors for H profiles | € 34,10 |  |
| EOMFOFF | Iron base 100x600 with connector | € 49,60 |  |
| ED100PF010 | 3x14 transparent blue PVC flat keder 200 m reel | € 79,38 |  |
| ED100PF030 | 3x14 transparent blue PVC flat keder 200 m reel | € 79,38 |  |
| ED100PF020 | 7x13 grey PVC hammer keder 100 m reel | € 207,90 |  |
| EOMFNASTRO | 2,8x13,5 transparent PVC flat keder 100 m reel | € 91,80 |  |

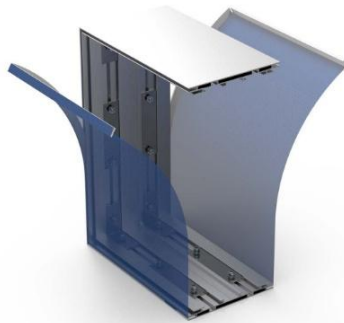

T-FLEX® 170/2

Aluminium profile for double side illuminated frames with keder-edged tensioned fabrics.
 For medium-to-large suspended or self-standing frames with feet.
 The double channel for the keder allows the application of an inner white textile to improve diffusion and to hide the electrical parts during the printed textile changeover.
 The use of reinforcement profiles is recommended for sides longer than 1,5 m.
 Corner connectors come complete with bolts and nuts.

For LED modules and power supplies see Ch. 6 (LED lighting).



| Code | Description | | | €/m | €/Pcs. |
|------------|-------------------------------------|-----------|-----------------|---------|----------|
| | Type | Material | Colour | | |
| ED370PL010 | Profile T-Flex 170/2 Double - 6,1 m | Aluminium | Anodized Silver | € 43,09 | € 262,86 |

Cutting and coloured painting/anodizing on demand

| Accessories Code | Description | €/each | Image |
|------------------|---|----------|---|
| ED110PF016 | Corner connector FastFix | € 3,36 |  |
| ED110PF017 | Straight connector FastFix | € 3,84 |  |
| ED196PF015 | Foot B steel 400x60 RAL 9006 | € 34,59 |  |
| ED196PF016 | Mounting plate for foot | € 2,23 |  |
| LOJ06105 | M5x20 screws, pack of 4 | € 2,40 |  |
| ED185PF020 | Support bracket 25 mm with holes incl. for 30x30x2 reinforcements (to fix it in the middle of the profile use self drilling/threading screws) | € 3,99 |  |
| ED196PF017 | Reinforcement square tube 30x30x2 RAL 9016, 6 m | € 10,61 |  |
| ED100PF010 | 3x14 transparent blue PVC flat keder 200 m reel | € 79,38 |  |
| ED100PF030 | 3x14 transparent blue PVC flat keder 200 m reel | € 79,38 |  |
| ED100PF020 | 7x13 grey PVC hammer keder 100 m reel | € 207,90 |  |
| EOMFNASTRO | 2,8x13,5 transparent PVC flat keder 100 m reel | € 91,80 |  |

PROFILES FOR TEXTILES TENSIONING

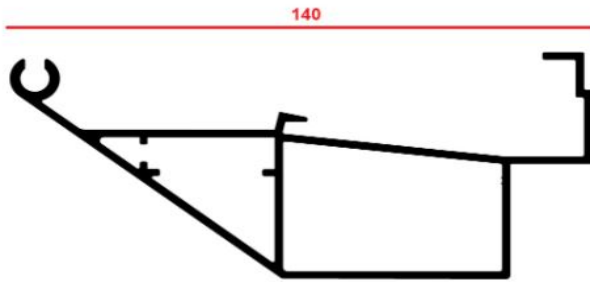

ECOPLUS 140

ON DEMAND

140 mm extruded aluminum profile prepared for the insertion of textiles tensioned and locked with a special profile. Suitable for lightboxes and large surfaces. Prepared to host LED lighting.

For LED modules and power supplies see Ch. 6 (LED lighting).

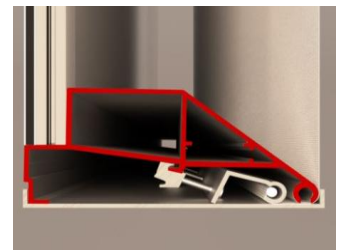
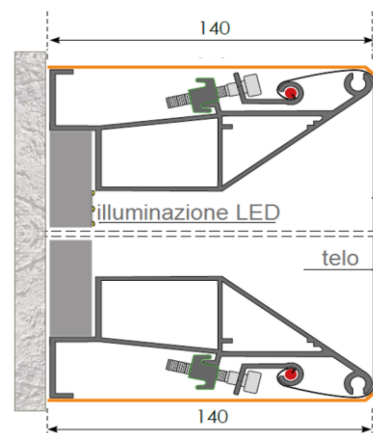

| Code | Description | €/Pcs. |
|------|--|-----------------|
| | Type | |
| SCS | On measure structure in assembly kit complete with accessories | ON QUOTE |

PROFILES FOR TEXTILES TENSIONING

CRYSTAL

Crystal line, made up of a wide range of profiles, is suitable for the creation of supports of any shape: from indoor structures, perfect for tensioning pictorial canvases, to outdoor structures, necessary for mega-billboards on walls or false ceilings. The Crystal profile is light, resistant, extremely adaptable. Easy to manipulate, cut and fix, Crystal does not cause creases in the sheets and leaves ample room for the creativity of the professional.

KT+ - P100: for the realization of frames and large format external structures.
KP - KTN: for the creation of small and medium format removable frames.
C - KL+ - KTA: for the creation of interior architectures and graphics on vehicles.
JN: indoor universal closing profiles.
JR: outdoor universal closing profiles.



Place the sheet approx. 10 cm larger.
 Secure the sheet with stoppers.
 Fit the PVC profile by removing stoppers.
 If required, cut the excess sheet.

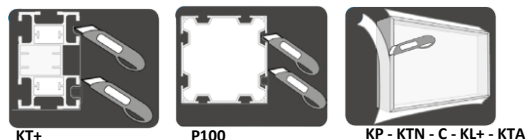

| Code | Description | | | €/m | €/Pcs. |
|--------|---------------------|-----------|-----------------|----------|----------|
| | Type | Material | Colour | | |
| CGKT+ | Profile KT+ - 3,5 m | Aluminium | Anodized Silver | € 65,15 | € 228,03 |
| CGP100 | Profile P100 - 5 m | Aluminium | Anodized Silver | € 101,33 | € 506,63 |

CGKT+
64 x 36,5 mm

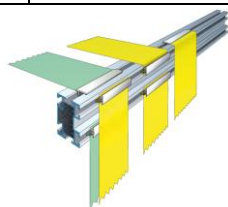

CGP100
100 x 100 mm

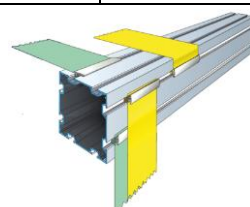

| | | | | | |
|-------|---------------------|-----------|-----------------|---------|---------|
| CGKP | Profile KP - 3,5 m | Aluminium | Anodized Silver | € 21,48 | € 75,16 |
| CGKTN | Profile KTN - 3,5 m | Aluminium | Anodized Silver | € 18,80 | € 65,80 |

CGKP
34 x 20 mm

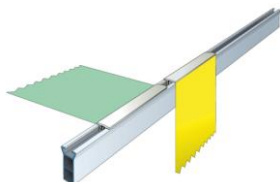

CGKTN
22 x 20 mm

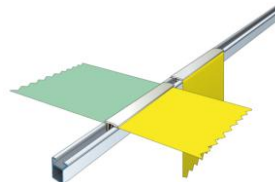

| | | | | | |
|-------|---------------------|-----------|-----------------|---------|---------|
| CGC | Profile C - 3,5 m | Aluminium | Anodized Silver | € 7,00 | € 24,50 |
| CGKL | Profile KL+ - 3,5 m | Aluminium | Anodized Silver | € 28,40 | € 99,40 |
| CGKTA | Profile KTA - 3,5 m | Aluminium | Anodized Silver | € 12,43 | € 43,49 |

CGC
20 x 8 mm

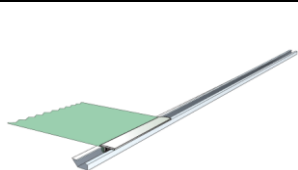

CGKL+
65 x 16 mm

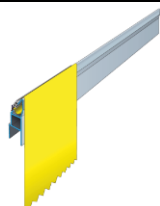

CGKTA
28 x 9 mm

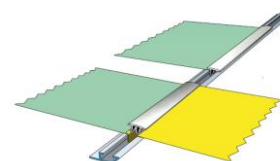

| | | | | | |
|------|--------------------|-----|-------|--------|---------|
| CGJN | Profile JN - 3,5 m | PVC | White | € 3,65 | € 12,78 |
| CGJR | Profile JR - 3,5 m | PVC | White | € 7,30 | € 25,55 |

CGJN
18 x 9 mm

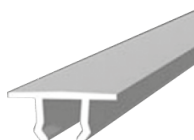

CGJR
18 x 9 mm



Mounting accessories available on demand

PROFILES FOR TEXTILES TENSIONING

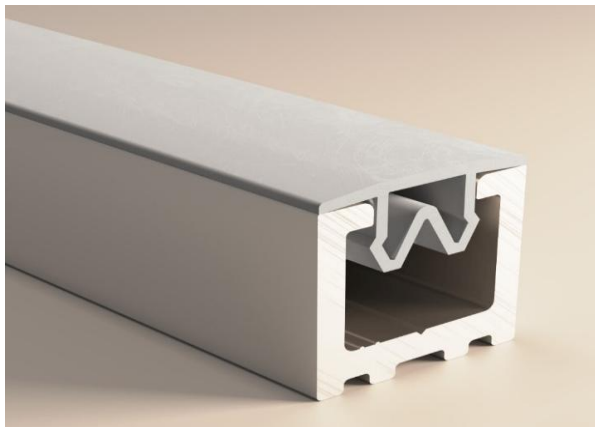

EXTENTION WALL

The XTW Extension Wall profile system allows for quick and easy tensioning of banners and printed fabrics both indoors and outdoors. It consists of two basic elements: the aluminium profile and a shockproof PVC cover RAL 7035 to be clicked onto it.

NEW LENGTH 6,05 M
45° CUT POSSIBLE

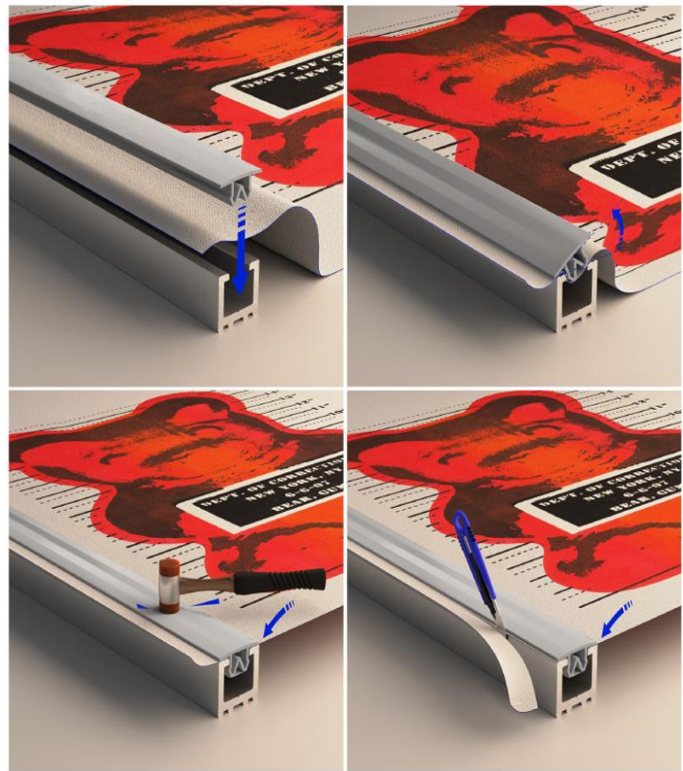

| Code | Description | | | €/m | €/Pcs. |
|------------|----------------|-----------|-----------------|---------|---------|
| | Type | Material | Colour | | |
| EEPLUS0200 | Profile 6,05 m | Aluminium | Anodized Silver | € 14,67 | € 88,03 |
| EEPLUS0201 | Profile 3,01 m | PVC | Anodized Silver | € 5,47 | € 16,40 |

PROFILES FOR TEXTILES TENSIONING





KEE KLAMP JOINTS

System joints malleable cast iron easy to use, can be used with standard pipe Ø 48 mm. They offer an easy way to build tubular structures as well as an economic alternative to the welding, joints are galvanized for corrosion resistance. To firmly lock the tube into the body of the joint, just tighten the screws with the hex wrench.

For signage poles see Ch. 2 (communication systems).
 For textiles accessories see Ch. 3 (digital print)

LAST PIECES IN STOCK SPECIAL PRICE PROMOTION

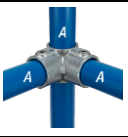

| Code | Description | €/Pc. | Image |
|--|--|---------|---|
| OKA128T | Hot galvanized cast iron Kee Klamp joints A12-8 T 45° opening | € 42,60 |  |
| OK208T | Hot galvanized cast iron Kee Klamp joints 20-8 T double angle | € 34,95 |  |
| OK258T | Hot galvanized cast iron Kee Klamp joints 25-8 Double T on line | € 29,85 |  |
| OK728S | Hot galvanized cast iron Kee Klamp joints 72-8 Step support | € 52,10 |  |
| OK148P | Kee Klamp cast iron joint extension 14-8 | € 23,95 |  |
| OK218P | Kee Klamp cast-iron through-joint two-way angle 21-8 | € 28,25 |  |
| Other types available on demand | | | |

| Accessories Code | Description | €/Pc. | Image |
|------------------|---------------------------------|---------|---|
| ES48300A | 3 m of Ø 48 antirotation pole | € 60,23 |  |
| ES48360A | 3,6 m of Ø 48 antirotation pole | € 72,28 | |

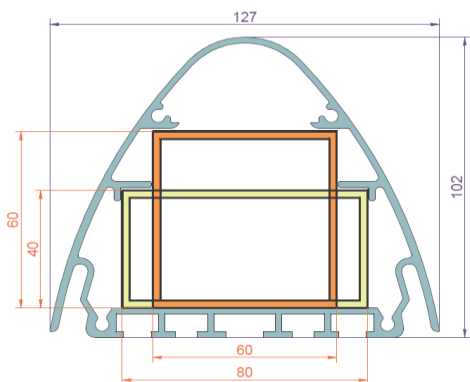

TM 100

Profile for single or double side large size totem for outdoor or indoor advertising.
A 60x60 mm or 80x40 mm square tube can be inserted inside the profile to allow the fixing onto steel plates or concrete bases.
Maximum sheet thickness: 4 mm.

For modules and power supplies see Ch. 6 (LED lighting).

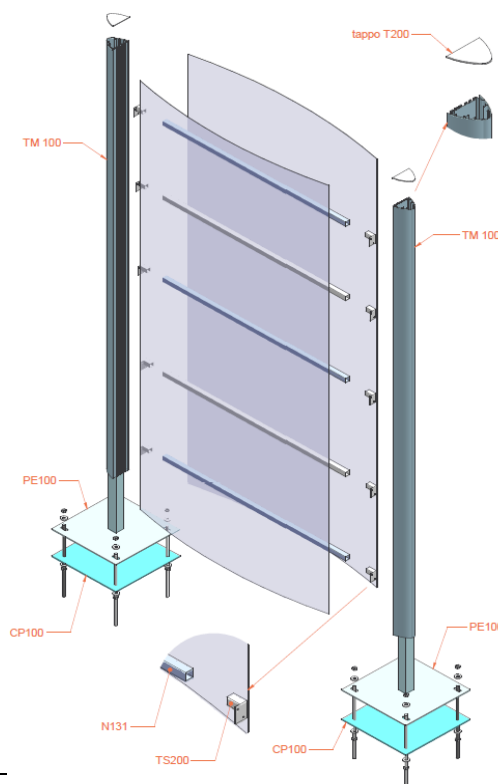

| Code | Description | | | €/m | €/Pcs. |
|---|---------------------------|-----------|-------------------------|----------|----------|
| | Type | Material | Colour | | |
| OPTM100A | Profile TM 100 - 6 m | Aluminium | Painted Silver RAL 9006 | € 100,75 | € 604,50 |
| OPTM100 | Profile TM 100 - 6 m | Aluminium | Mill Finish | € 83,48 | € 500,85 |
| ON131 | Square tube 30x30x2 - 6 m | Aluminium | Mill Finish | € 15,93 | € 95,58 |
| Assembled Totem or in mounting kit on demand | | | | | |

| Accessories Code | Description | €/Pack. | Image |
|------------------|--|-----------------|-------|
| OPT200 | Pair of aluminium caps with screws included | € 22,85 | |
| OPTS200 | Left and right brackets | € 40,18 | |
| OBB135 | 13x13x35 8 MA screw with nut | € 0,35 | |
| OPTMG100 | Pair of backplate with anchor bolts included | Price on demand | |
| OPTPE100 | Pair of floor plates 50x50 with tube 60x60, 3 m height | Price on demand | |

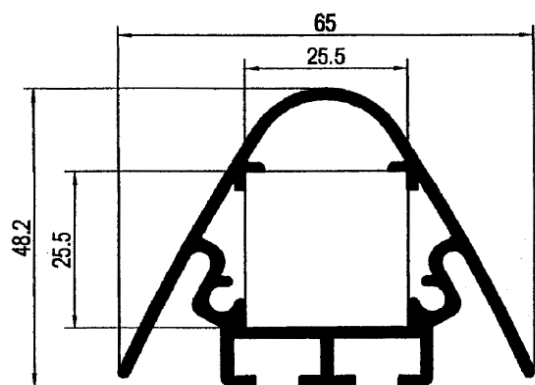

TM 500

Profile for single or double side medium-large size totem for outdoor or indoor advertising.
 A 25x25 mm tube can be inserted inside the profile to allow the fixing onto steel plates or concrete bases.



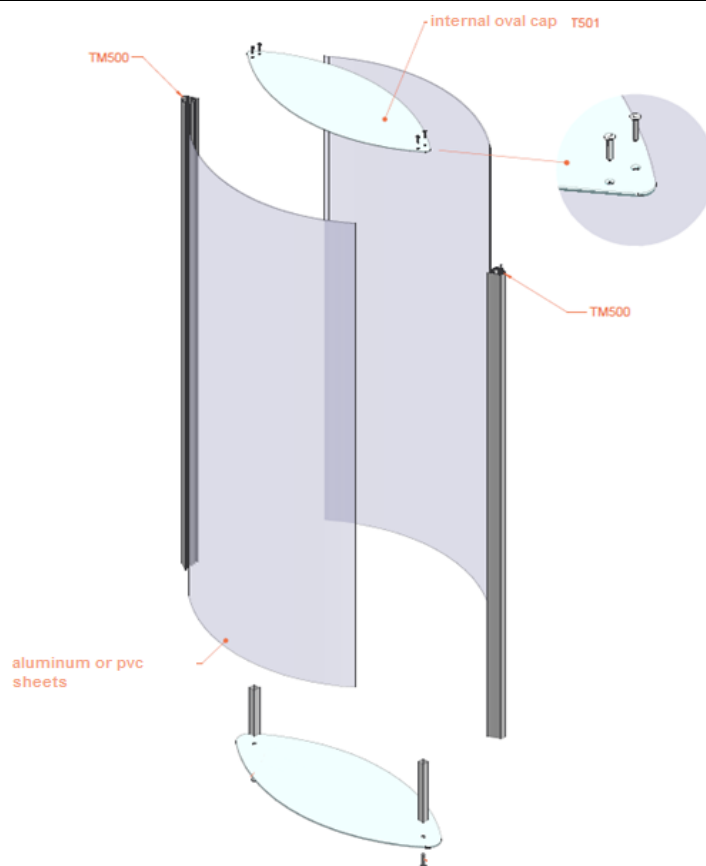

Maximum sheet thickness: 4 mm.

For modules and power supplies see Ch. 6 (LED lighting).



| Code | Description | | | €/m | €/Pcs. |
|-----------|-----------------------------|-----------|-----------------|---------|----------|
| | Type | Material | Colour | | |
| OPTM500A | Profile TM 500 - 6 m | Aluminium | Anodized Silver | € 30,73 | € 184,35 |
| OPTM500 | Profile TM 500 - 6 m | Aluminium | Mill Finish | € 25,33 | € 151,95 |
| OP015111A | Square tube 15x15x1,5 - 6 m | Aluminium | Mill Finish | € 6,13 | € 36,75 |

Assembled Totem or in mounting kit on demand

| Accessories Code | Description | €/Pack. | Image |
|------------------|---|-----------------|---|
| OPT500 | Pair of PVC caps | € 12,83 |  |
| OPTS500 | Left and right brackets | € 24,18 |  |
| OBB130 | 13x13 6 MA screw with nut | € 0,15 |  |
| OPPI500 | Pair of floor plates with tube 25x25,1 m height | Price on demand |  |

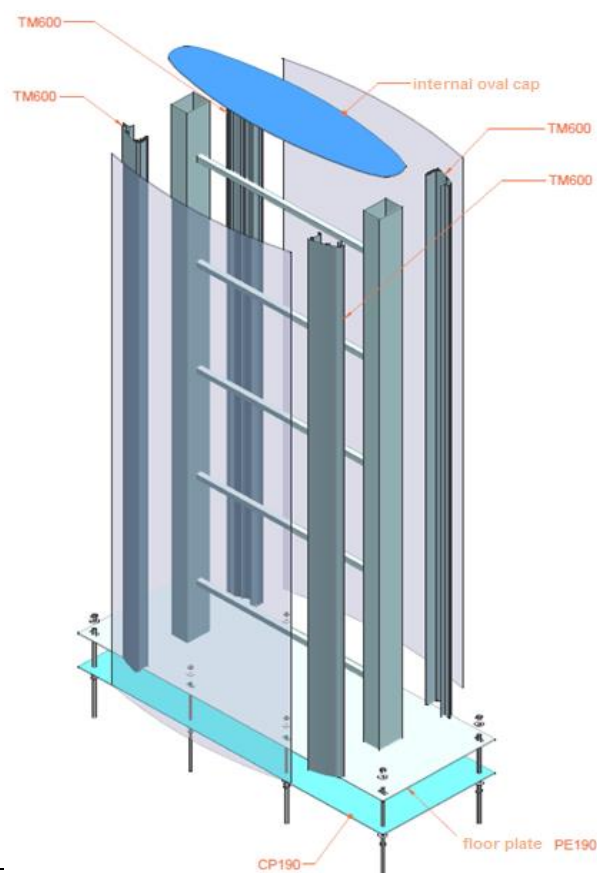
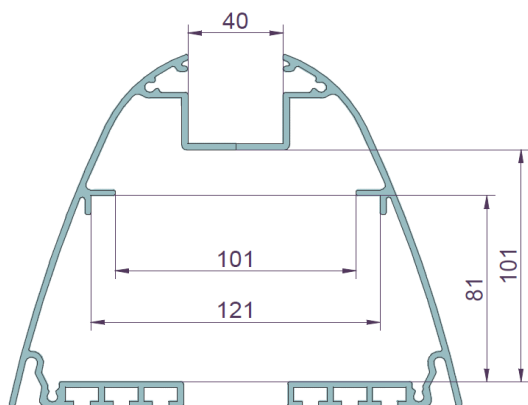

TM 600

Profile for single or double side large size totem for outdoor advertising.
This is not a self-standing profile with its own connecting system.
It has to be placed as a cover onto a pre-existing iron structure made with 100x100 mm or 120x80 mm square tubes can be inserted inside the profile to allow the fixing onto steel plates or concrete bases.
The channel on the outer edge allows the installation of a decorative linear illumination.
Maximum sheet thickness: 4 mm.

For modules and power supplies see Ch. 6 (LED lighting).

| Code | Description | | | €/m | €/Pcs. |
|----------|----------------------|-----------|-----------------|---------|----------|
| | Type | Material | Colour | | |
| OPTM600A | Profile TM 600 - 6 m | Aluminium | Anodized Silver | € 69,40 | € 416,40 |
| OPTM600 | Profile TM 600 - 6 m | Aluminium | Mill Finish | € 62,03 | € 372,15 |

Assembled Totem or in mounting kit on demand

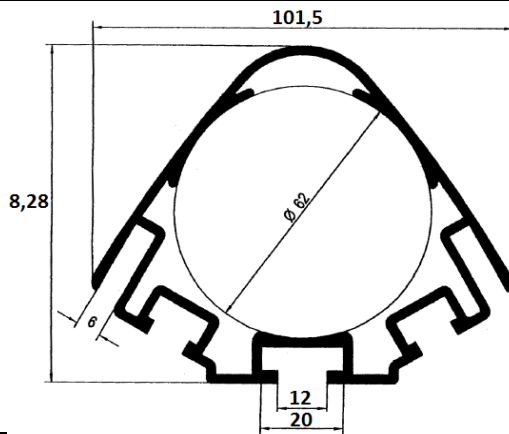

TM 300



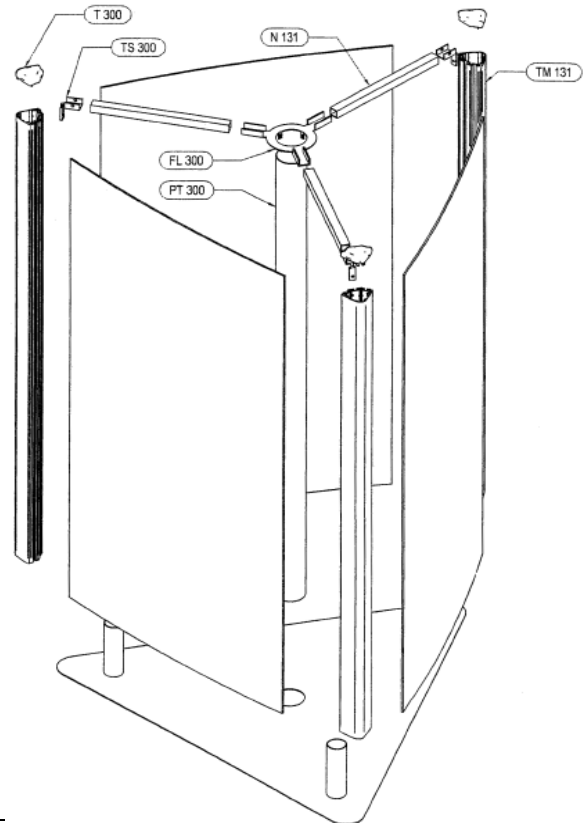

Profile for triple side medium-large size totem for outdoor or indoor advertising.
 A 60 mm round tube can be inserted inside the profile to allow the fixing onto steel plates or concrete bases.
 Maximum sheet thickness: 5 mm.

For modules and power supplies see Ch. 6 (LED lighting).

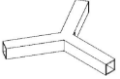
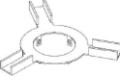

| Code | Description | | | €/m | €/Pcs. |
|----------|---------------------------|-----------|-----------------|---------|----------|
| | Type | Material | Colour | | |
| OPTM300A | Profile TM 300 - 6 m | Aluminium | Anodized Silver | € 70,75 | € 424,50 |
| OPTM300 | Profile TM 300 - 6 m | Aluminium | Mill Finish | € 57,30 | € 343,80 |
| ON131 | Square tube 30x30x2 - 6 m | Aluminium | Mill Finish | € 15,93 | € 95,58 |

Assembled Totem or in mounting kit on demand

| Accessories Code | Description | €/Pack. | Image |
|------------------|--|-----------------|---|
| OPT300 | PVC cap | € 8,50 |  |
| OPTS300 | Bracket with screws and nuts included | € 22,00 |  |
| OBB135 | 13x13x35 8 MA screw with nut | € 0,35 |  |
| OPTY300 | Connection for tubes 25x25x2 | € 20,28 |  |
| OPFL300 | 4 mm centrale flange for Ø 100 mm pole | € 83,70 |  |
| OPPB300 | Floor plate for double sided structure with Ø 60 mm tube | Price on demand |  |

PROFILES FOR RIGID PANELS

FRAME PROFILES





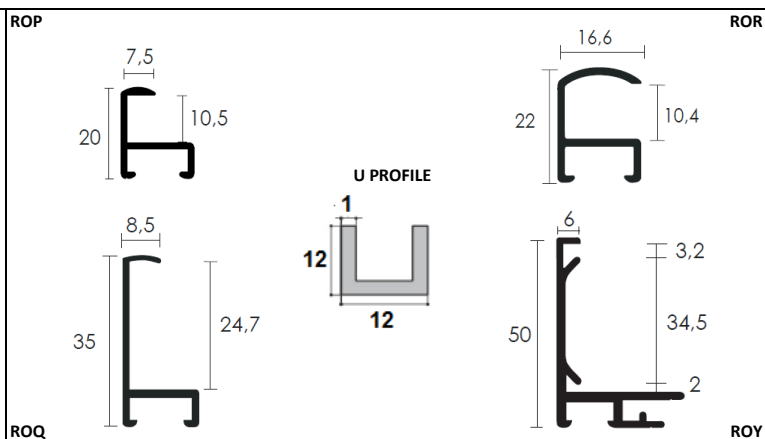

ROP: basic profile with simple design for the finishing of panels up to 10 mm thick.
ROR: to have a more visible aluminium edge all around the picture.
ROQ: to edge thicker panels or to give the impression of high thickness with a thinner panel.
ROY: for frames with protective glass or for thin LED lightboxes.
U: only for 10 mm thick panels.

For rigid panels see Ch. 1 (plastic material).
 For LED modules and power supplies see Ch. 6 (LED lighting).

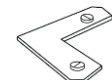

| Code | Description | | | €/m | €/Pcs. |
|------------------------------------|----------------------|-----------|-----------------|---------|----------|
| | Type | Material | Colour | | |
| EROP4000A | Prof. ROP 4000 - 3 m | Aluminium | Anodized Silver | € 6,42 | € 19,26 |
| EROP2000O | Prof. ROP 2000 - 3 m | Aluminium | Gloss Gold | € 8,60 | € 25,79 |
| EROP1000B | Prof. ROP 1000 - 3 m | Aluminium | White | € 8,19 | € 24,57 |
| EROP5000N | Prof. ROP 5000 - 3 m | Aluminium | Black | € 8,19 | € 24,57 |
| EROP6000O | Prof. ROP 6000 - 3 m | Aluminium | Anodized Gold | € 8,19 | € 24,57 |
| EROP8000A | Prof. ROP 8000 - 3 m | Aluminium | Gloss Silver | € 12,21 | € 36,63 |
| EROR4000A | Prof. ROR 4000 - 3 m | Aluminium | Anodized Silver | € 14,76 | € 44,28 |
| EROQ4000A | Prof. ROQ 4000 - 3 m | Aluminium | Anodized Silver | € 14,85 | € 44,55 |
| EROQ9000N | Prof. ROQ 9000 - 3 m | Aluminium | Anodized Black | € 16,62 | € 49,86 |
| EROY4000A | Prof. ROY 4000 - 3 m | Aluminium | Anodized Silver | € 38,09 | € 114,27 |
| NZUN00 <small>phase out</small> | Prof. U - 3 m | Aluminium | Black | € 2,83 | € 8,50 |

For quantities cutting and coloured painting/anodizing on demand

| Accessories Code | Description | €/Pack. | Image |
|------------------|--|----------|---|
| EROA10000 | Compensation spring thickness | € 0,49 |  |
| EROA20000 | Hooks for aluminium frames | € 1,00 |  |
| EROA300000 | Angle plate and counterplate | € 1,43 |  |
| NZCGAPAN | 200 pcs. package of self adhesive click in plastic 50 x 35 mm | € 102,38 |  |
| NZFACL | 200 pcs. package of click for lightweight panels, Sandwich paper and KAPA panels | € 108,00 |  |
| NZCGAPVC | 100 pcs. package of click for PVC panels semi-expanded and Sandwich PVC | € 120,00 |  |

PROFILES FOR RIGID PANELS

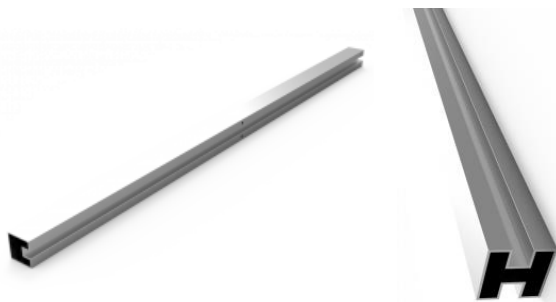





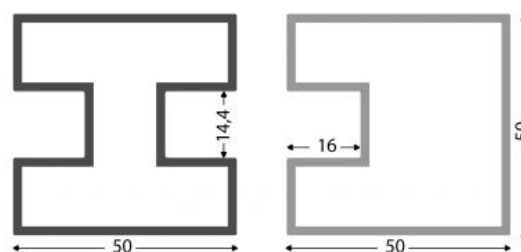



TERRACE® 50

Profile system for separation screens with glass or plastic panels.
 Perfect for social-distancing.
 Very simple with just two kind of profiles, doesn't need mitred cut.
 The rubber profile is used to hold glass and plastic panels 4 to 5 mm thick.
 The single side adhesive foam tape is used to compensate the thickness of 8 to 10 mm thick panels.
 The very wide steel feet make the screens both stable and movable.



| Code | Description | | | €/m | €/Pcs. |
|------------|-------------------------|-----------|-----------------|---------|----------|
| | Type | Material | Colour | | |
| ED650PF010 | Prof. Terrace C - 6,1 m | Aluminium | Anodized Silver | € 22,70 | € 138,47 |
| ED650PF011 | Prof. Terrace H - 6,1 m | Aluminium | Anodized Silver | € 26,85 | € 163,79 |
| ED650PF100 | Glass rubber - 100 m | Aluminium | Anodized Silver | € 7,20 | € 720,00 |

Cutting on demand

| Accessories Code | Description | €/Pack. | Image |
|------------------|--|---------|---|
| ED650PF201 | Anod wall mounting plate | € 39,83 |  |
| ED650PF202 | Anod collection solution | € 20,28 |  |
| ED650PF203 | Anod hinge solution | € 19,08 |  |
| ED650PF204 | White Plastic assembly block | € 3,85 |  |
| ED650PF205 | Synthetic black end piece | € 0,88 |  |
| ED650PF206 | 11,9 mm of synthetic cover | € 0,58 |  |
| ED650PF300 | Steel foot | € 82,25 |  |
| ED650PF301 | Square foot | € 70,03 |  |
| HG40311530 | 3 mm of monoadhesive foam SG4031, 15 mm x 30 m | € 16,08 |  |

PROFILES FOR RIGID PANELS

SQUAREFIX®

SquareFix is a system of square tubes and selfclamping plastic connecting pieces perfect to build Covid protections and separation.

The wide range of components adapts all situations such as pre-existing furniture.

Joints have a steel core for maximum stiffness.

The single-winged profiles accepts panels of any thickness.

The panel is fixed to the wing by means of adhesive tapes, sealants or screws.

Textile walls can be made thank to the dedicated profile for fabrics.

SquareFix can be used for the construction of racks, poster displays, tables, but also for shop displays, fabric frames, signs.



PHASE OUT

| Code | Description | | | €/m | €/Pcs. |
|------------|------------------------------|-----------|-----------------|---------|---------|
| | Type | Material | Colour | | |
| ED600PF010 | Prof. Squarefix - 6 m | Aluminium | Anodized Silver | € 8,63 | € 51,75 |
| ED600PF011 | Prof. Squarefix single - 6 m | Aluminium | Anodized Silver | € 11,40 | € 68,40 |

ED600PF010

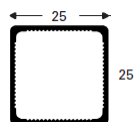
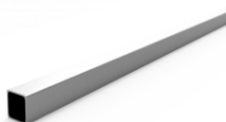

ED600PF011

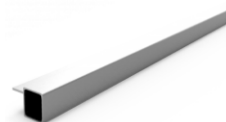

| | | | | | |
|------------|-----------------------------------|-----------|-----------------|---------|---------|
| ED600PF012 | Prof. Squarefix double 180° - 6 m | Aluminium | Anodized Silver | € 13,65 | € 81,90 |
| ED600PF013 | Prof. Squarefix 90° low - 6 m | Aluminium | Anodized Silver | € 13,58 | € 81,45 |

ED600PF012



ED600PF013

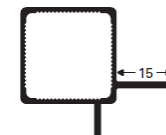
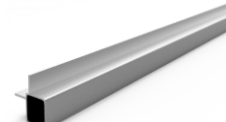

| | | | | | |
|------------|--------------------------------------|-----------|-----------------|---------|----------|
| ED600PF014 | Prof. Squarefix 90° high - 6 m | Aluminium | Anodized Silver | € 13,65 | € 81,90 |
| ED600PF015 | Prof. Squarefix textile single - 6 m | Aluminium | Anodized Silver | € 17,13 | € 102,75 |

ED600PF014

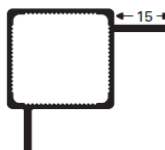
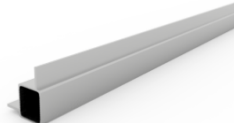



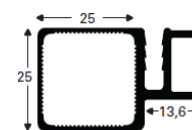
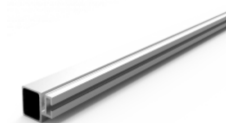







ED600PF015



Cutting on demand

ACCESSORIES FOR SQUAREFIX

| PHASE OUT | | | |
|------------------|---|---------|---|
| Accessories Code | Description | €/Pack. | Image |
| ED600PF100 | 25x25 black Squarefix insert cap | € 0,78 |  |
| ED600PF101 | 25x25 Squarefix 2 way piece 180° | € 2,08 |  |
| ED600PF102 | 25x25 Squarefix 2 way piece 90° | € 3,73 |  |
| ED600PF103 | 25x25 Squarefix 3 way piece flat 180°/90° | € 4,63 |  |
| ED600PF104 | 25x25 Squarefix 3 way piece 90°/90° | € 5,20 |  |
| ED600PF105 | 25x25 Squarefix 4 way piece flat | € 6,40 |  |
| ED600PF106 | 25x25 Squarefix 4 way piece 180°/90° | € 6,28 |  |
| ED600PF107 | 25x25 Squarefix 5 way piece 180°/90° | € 7,03 |  |
| ED600PF108 | 25x25 Squarefix 6 way piece 180°/90° | € 8,93 |  |
| HG0641233 | 0,64 mm double adhesive Scapa A1130TP, 12 mm x 33 m | € 33,23 |  |

SYSTEM 25

System of aluminium square profiles and ABS joints to make cabins, boxes, walls, displays and many other self standing structures.
The structures can be assembled in the place of installation.
Profiles for panels up to 6 mm or up to 10 mm thick are available.



| Code | Description | | | €/m | €/Pcs. |
|---------|-------------------------|-----------|-----------------|---------|---------|
| | Type | Material | Colour | | |
| ON120 | Square tube N120 - 6 m | Aluminium | Mill Finish | € 9,88 | € 59,25 |
| ON120A | Square tube N120 - 6 m | Aluminium | Anodized Silver | € 12,30 | € 73,80 |
| ON2510 | Square tube N2510 - 6 m | Aluminium | Mill Finish | € 11,68 | € 70,05 |
| ON2510A | Square tube N2510 - 6 m | Aluminium | Anodized Silver | € 14,60 | € 87,60 |

N120

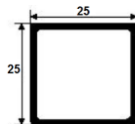

N2510

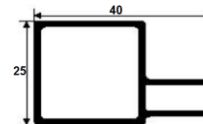

| | | | | | |
|---------|-------------------------|-----------|-----------------|---------|----------|
| ON2520 | Square tube N2520 - 6 m | Aluminium | Mill Finish | € 14,98 | € 89,85 |
| ON2520A | Square tube N2520 - 6 m | Aluminium | Anodized Silver | € 18,03 | € 108,15 |
| ON2530 | Square tube N2530 - 6 m | Aluminium | Mill Finish | € 14,93 | € 89,55 |
| ON2530A | Square tube N2530 - 6 m | Aluminium | Anodized Silver | € 17,98 | € 107,85 |

N2520

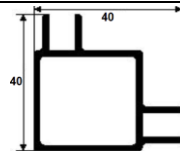

N2530

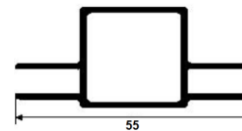

| | | | | | |
|---------|-------------------------|-----------|-----------------|---------|----------|
| ON2540 | Square tube N2540 - 6 m | Aluminium | Mill Finish | € 13,18 | € 79,05 |
| ON2540A | Square tube N2540 - 6 m | Aluminium | Anodized Silver | € 15,85 | € 95,10 |
| ON2550 | Square tube N2550 - 6 m | Aluminium | Mill Finish | € 16,80 | € 100,80 |
| ON2550A | Square tube N2550 - 6 m | Aluminium | Anodized Silver | € 20,25 | € 121,50 |

N2540

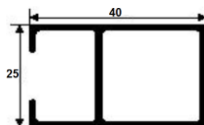

N2550

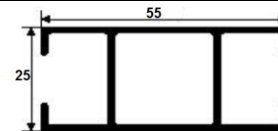





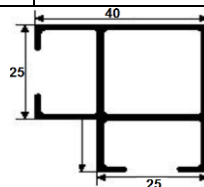



| | | | | | |
|---------|-------------------------|-----------|-----------------|---------|----------|
| ON2560 | Square tube N2560 - 6 m | Aluminium | Mill Finish | € 16,80 | € 100,80 |
| ON2560A | Square tube N2560 - 6 m | Aluminium | Anodized Silver | € 20,25 | € 121,50 |

N2560



30 mm tubes and other colours (bronze and black) on demand
For quantities cutting on demand

| Accessories Code | Description | €/Pack. | Image |
|------------------|---|---------|---|
| OG250 | Terminal cap for 25 mm tube | € 0,75 |  |
| OG251 | ABS Coupling 2 way line for 25 mm tube | € 4,08 |  |
| OG252 | ABS Coupling 2 way angle for 25 mm tube | € 4,08 |  |
| OG253 | ABS Coupling 3 way line for 25 mm tube | € 4,43 |  |
| OG254 | ABS Coupling 3 way angle for 25 mm tube | € 4,43 |  |
| OG255 | ABS Coupling 4 way line for 25 mm tube | € 4,85 |  |
| OG256 | ABS Coupling 4 way angle for 25 mm tube | € 4,85 |  |
| OG257 | ABS Coupling 5 way angle for 25 mm tube | € 5,23 |  |
| OG258 | ABS Coupling 6 way angle for 25 mm tube | € 5,80 |  |

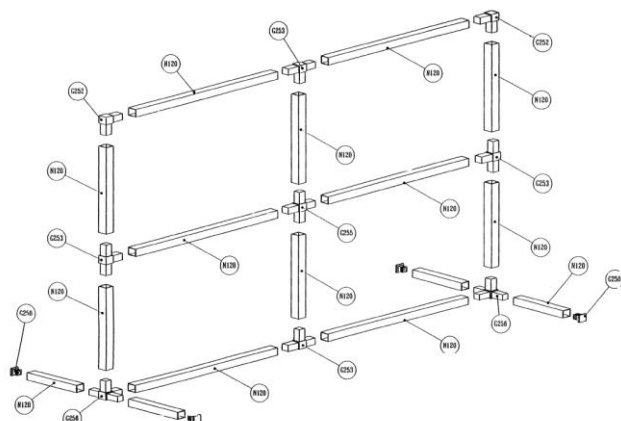
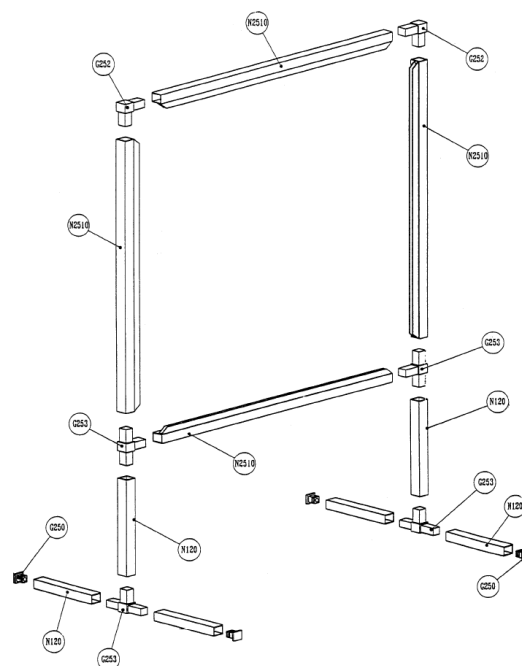
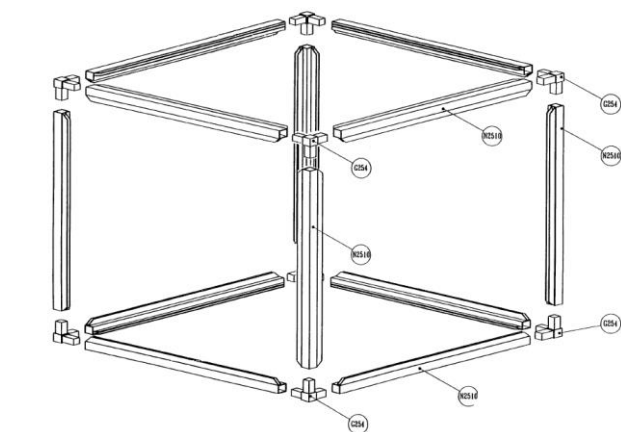



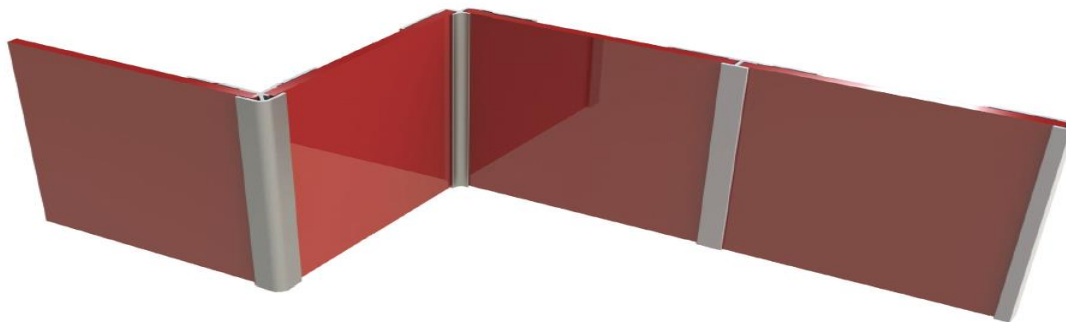



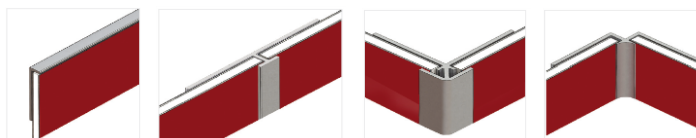

FINISHING PROFILES

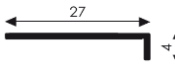
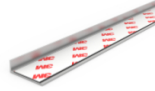
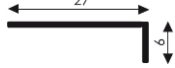
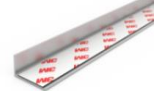

EDGETRIM ADHESIVE PROFILES FOR PANELS

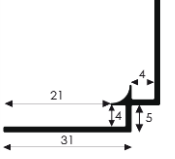
Wide range of profiles with adhesive tape in various shapes, for finishing panel edges or for linear or corner joints. In silver anodised aluminium, some are also available in anodised gold or painted dark grey RAL7021 on request. A practical, economical and quick solution for finishing and adding rigidity. On request, also available without adhesive tape.

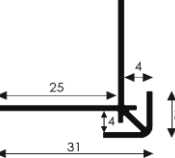

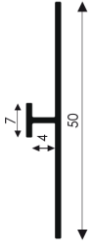
| Code | Description | | | €/m | €/Pc. | Picture |
|------------|-----------------------------|---------------------------|---------|---------|--|---|
| | Type | Material | Color | | | |
| ED200AA003 | L-profile 4 - 4.1 m | Aluminium Anodised silver | 5,78 € | 23,68 € |  |  |
| ED200AA004 | L-profile 6 - 4.1 m | Aluminium Anodised silver | 5,90 € | 24,19 € |  |  |
| ED200AA005 | L-profile 10 - 4.1 m | Aluminium Anodised silver | 6,43 € | 26,35 € |  |  |
| ED200AA006 | Inside corner 90° - 4.1 m | Aluminium Anodised silver | 10,86 € | 44,51 € |  |  |
| ED200AA007 | External corner 90° - 4.1 m | Aluminium Anodised silver | 12,10 € | 49,59 € |  |  |
| ED200AA002 | Connection - 4.1 m | Aluminium Anodised silver | 10,63 € | 43,57 € |  |  |

Customised cutting and painting/anodising in other colours on request

STRIP LED PROFILES



M PROFILE

Profile for flat surfaces

Compact profile in natural anodised extruded aluminium for LED bar realizations.

Accessories set available: caps, lens, racks, diffusers, etc.

Suitable for indoor use.



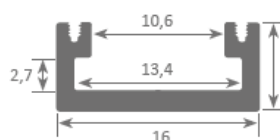

Excellent heating dissipation.

The profile is ideal for using on wall surfaces, furniture, shelves and similar areas, where we require a minimalist profile with very reduced dimensions.

For LED strip see Ch. 6 (LED lighting).



| Code | Description | | | | €/Pcs. |
|----------|-----------------|-----------|-----------------|------------|---------|
| | Type | Material | Colour | Pcs./Pack. | |
| LOZ2PM01 | Profile M - 2 m | Aluminium | Anodized Silver | 1 | € 14,00 |

| Accessories Code | Description | €/Pack. | Image |
|------------------|---|---------|---|
| LOZ2PMT | 10 pcs. package of grey end caps with hole | € 9,91 |  |
| LOZ2PMT/F | 10 pcs. package of grey end caps without hole | € 9,91 |  |
| LOZ2P01/1 | 2 m of transparent methacrylate diffuser | € 7,98 |  |
| LOZ2P02/1 | 2 m of satin methacrylate diffuser | € 7,98 | |
| LOZ2P03/1 | 2 m of opaline methacrylate diffuser | € 7,98 | |
| LOZ2PMG | 10 pcs. package of fixing plates | € 9,91 |  |

STRIP LED PROFILES



R PROFILE

Profile for flat surfaces

Compact profile in natural anodised extruded aluminium for LED bar realizations.
 Accessories set available: caps, lens, racks, diffusers, etc.

Suitable for indoor use.



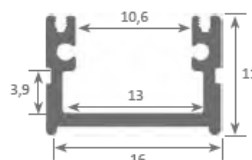

Excellent heating dissipation.

The profile is ideal for using on wall surfaces, furniture, shelves and similar areas.

For LED strip see Ch. 6 (LED lighting).



| Code | Description | | | | €/Pcs. |
|----------|-----------------|-----------|-----------------|------------|---------|
| | Type | Material | Colour | Pcs./Pack. | |
| LOZ2PR01 | Profile R - 2 m | Aluminium | Anodized Silver | 1 | € 12,82 |

| Accessories Code | Description | €/Pack. | Image |
|------------------|---|---------|---|
| LOZ2PRT | 10 pcs. package of grey end caps with hole | € 9,91 |  |
| LOZ2PRT/F | 10 pcs. package of grey end caps without hole | € 9,91 |  |
| LOZ2P01/1 | 2 m of transparent methacrylate diffuser | € 7,98 |  |
| LOZ2P02/1 | 2 m of satin methacrylate diffuser | € 7,98 | |
| LOZ2P03/1 | 2 m of opaline methacrylate diffuser | € 7,98 | |
| LOZ2PRG | 10 pcs. package of fixing plates | € 9,91 |  |

STRIP LED PROFILES

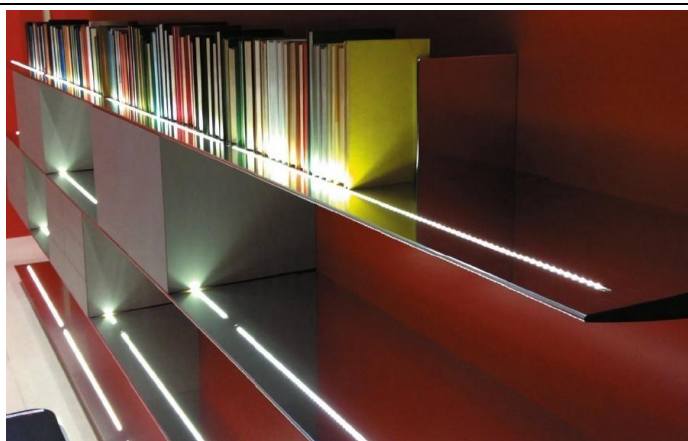

F PROFILE



Profile for embedding

Compact profile in natural anodised extruded aluminium for LED bar realizations.
 Accessories set available: caps, lens, racks, diffusers, etc.
 Suitable for indoor use.
 Excellent heating dissipation.
 Ideal for embedding in furniture, shelving and similar areas, where we require a minimalist profile with very reduced dimensions.

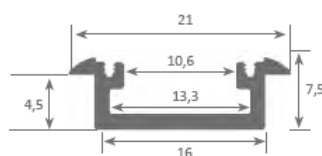
For LED strip see Ch. 6 (LED lighting).



| Code | Description | | | | €/Pcs. |
|----------|-----------------|-----------|-----------------|------------|---------|
| | Type | Material | Colour | Pcs./Pack. | |
| LOZ2PF01 | Profile F - 2 m | Aluminium | Anodized Silver | 1 | € 15,26 |

| Accessories Code | Description | €/Pack. | Image |
|------------------|---|---------|---|
| LOZ2PFT/F | 10 pcs. package of grey end caps without hole | € 9,91 |  |
| LOZ2P01/1 | 2 m of transparent methacrylate diffuser | € 7,98 |  |
| LOZ2P02/1 | 2 m of satin methacrylate diffuser | € 7,98 | |
| LOZ2P03/1 | 2 m of opaline methacrylate diffuser | € 7,98 | |
| LOZ2PMG | 10 pcs. package of fixing plates | € 9,91 |  |

STRIP LED PROFILES

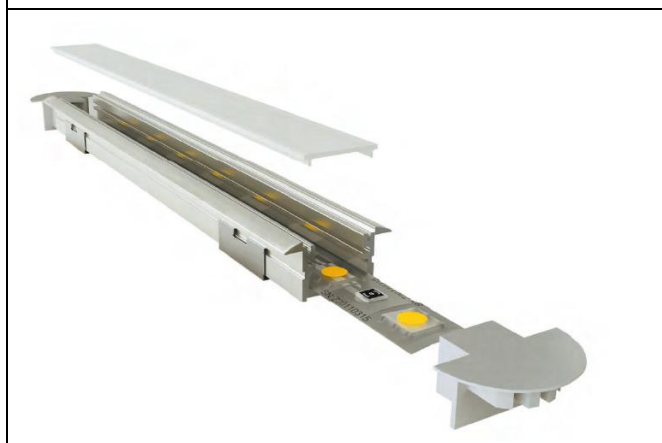

B PROFILE

Profile for embedding

Compact profile in natural anodised extruded aluminium for LED bar realizations.

Accessories set available: caps, lens, racks, diffusers, etc.

Suitable for indoor use.



Excellent heating dissipation.

Ideal for embedding in furniture, shelving and similar areas where we require a profile with a dot-free effect.

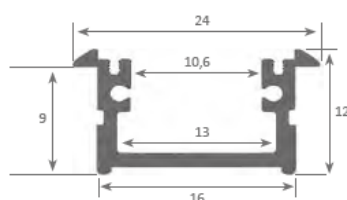
For LED strip see Ch. 6 (LED lighting).



| Code | Description | | | | €/Pcs. |
|----------|-----------------|-----------|-----------------|------------|---------|
| | Type | Material | Colour | Pcs./Pack. | |
| LOZ2PB01 | Profile B - 2 m | Aluminium | Anodized Silver | 1 | € 14,07 |

| Accessories Code | Description | €/Pack. | Image |
|------------------|---|---------|---|
| LOZ2PBT/F | 10 pcs. package of grey end caps without hole | € 9,91 |  |
| LOZ2P01/1 | 2 m of transparent methacrylate diffuser | € 7,98 |  |
| LOZ2P02/1 | 2 m of satin methacrylate diffuser | € 7,98 | |
| LOZ2P03/1 | 2 m of opaline methacrylate diffuser | € 7,98 | |
| LOZ2PRG | 10 pcs. package of fixing plates | € 9,91 |  |

STRIP LED PROFILES



S PROFILE



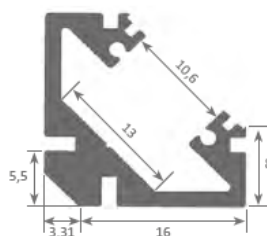

Angular profile

Compact profile in natural anodised extruded aluminium for LED bar realizations.
 Accessories set available: caps, lens, racks, diffusers, etc.
 Suitable for indoor use.
 Excellent heating dissipation.
 Ideal for wall surfaces, furniture, shelving and similar areas where we require an angled and continuous light emission along with an optimum heat dissipation.

For LED strip see Ch. 6 (LED lighting).



| Code | Description | | | | €/Pcs. |
|----------|-----------------|-----------|-----------------|------------|---------|
| | Type | Material | Colour | Pcs./Pack. | |
| LOZ2PS01 | Profile S - 2 m | Aluminium | Anodized Silver | 1 | € 20,73 |

| Accessories Code | Description | €/Pack. | Image |
|------------------|---|---------|---|
| LOZ2PST | 10 pcs. package of grey end caps with hole | € 9,91 |  |
| LOZ2PST/F | 10 pcs. package of grey end caps without hole | € 9,91 |  |
| LOZ2P01/1 | 2 m of transparent methacrylate diffuser | € 7,98 |  |
| LOZ2P02/1 | 2 m of satin methacrylate diffuser | € 7,98 | |
| LOZ2P03/1 | 2 m of opaline methacrylate diffuser | € 7,98 | |
| LOZ2PSG | 10 pcs. package of fixing plates | € 9,91 |  |

STRIP LED PROFILES



P PROFILE

Profile for vertical and horizontal light bars

Compact profile in natural anodised extruded aluminium for LED bar realizations.

Accessories set available: caps, lens, racks, diffusers, etc.

Suitable for indoor use.



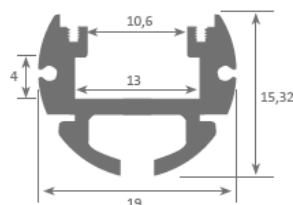

Excellent heating dissipation.

The profile has a wide range of applications, examples of which include ceiling suspended luminaires, luminaires for displaying paintings, wardrobe garment rails, floor or wall mounted luminaires, etc.

For LED strip see Ch. 6 (LED lighting).



| Code | Description | | | | €/Pcs. |
|----------|-----------------|-----------|-----------------|------------|---------|
| | Type | Material | Colour | Pcs./Pack. | |
| LOZ2PP01 | Profile P - 2 m | Aluminium | Anodized Silver | 1 | € 19,82 |

| Accessories Code | Description | €/Pack. | Image |
|------------------|---|---------|---|
| LOZ2PPT | 10 pcs. package of grey end caps with hole | € 9,91 |  |
| LOZ2PPT/F | 10 pcs. package of grey end caps without hole | € 9,91 |  |
| LOZ2P01/1 | 2 m of transparent methacrylate diffuser | € 7,98 |  |
| LOZ2P02/1 | 2 m of satin methacrylate diffuser | € 7,98 | |
| LOZ2P03/1 | 2 m of opaline methacrylate diffuser | € 7,98 | |
| LOZ2PPG | 10 pcs. package of fixing plates | € 18,91 |  |

STRIP LED PROFILES



D PROFILE



Workable waterproof profile

Compact profile in natural anodised extruded aluminium for LED bar realizations.
 End caps and covers included.
 Suitable for indoor use.
 Excellent heating dissipation.
 Suitable for a wide range of floor lighting, for example stairs, bathrooms and theatres, amongst others.

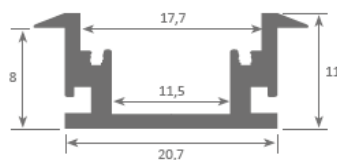
For LED strip see Ch. 6 (LED lighting).



| Code | Description | | | | €/Pcs. |
|----------|-----------------|-----------|-----------------|------------|---------|
| | Type | Material | Colour | Pcs./Pack. | |
| LOZ2PD01 | Profile D - 2 m | Aluminium | Anodized Silver | 1 | € 19,82 |

| Accessories Code | Description | €/Pack. | Image |
|------------------|---------------------------------------|---------|---|
| LOZ2PDT/F | 10 pcs. package of aluminium end caps | € 27,84 |  |
| LOZ2PDOC | 2 m of opaline methacrylate diffuser | € 14,24 |  |
| LOZ2P000 | Sealant silicone | € 14,85 |  |

STRIP LED PROFILES



H PROFILE



Profile for ceiling or wall mounting

Compact profile in natural anodised extruded aluminium for LED bar realizations.
 End caps included.
 Suitable for indoor use.
 Excellent heating dissipation.
 This profile can be used for many different purposes, such as ceilings and signage, due to its ultra thin methacrylate with optical effect.
 Its etched methacrylate surface makes it ideal for hanging (display signs with diffused lighting).

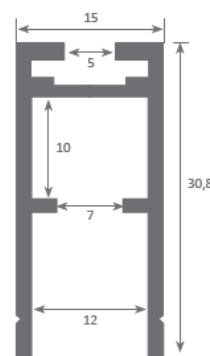
For LED strip see Ch. 6 (LED lighting).



| Code | Description | | | | €/Pcs. |
|----------|-----------------|-----------|-----------------|------------|---------|
| | Type | Material | Colour | Pcs./Pack. | |
| LOZ2PH01 | Profile H - 3 m | Aluminium | Anodized Silver | 1 | € 36,24 |

| Accessories Code | Description | €/Pack. | Image |
|------------------|---|---------|---|
| LOZ2PHT/F | 10 pcs. package of grey end caps without hole | € 25,97 |  |
| LOZ2PHSQ | 10 pcs. package of steel brackets | € 16,85 |  |

STRIP LED PROFILES

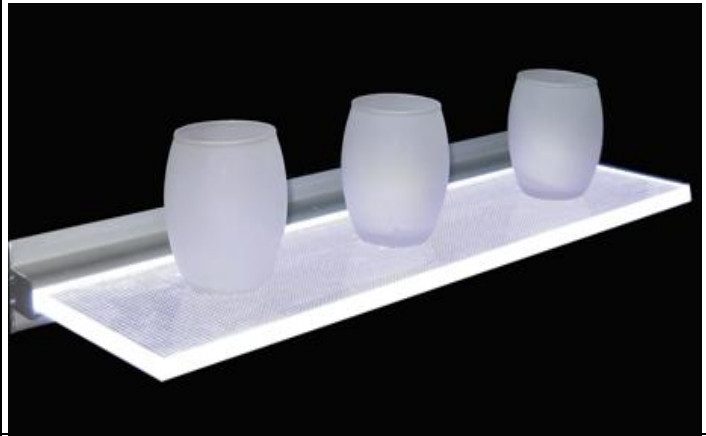

G PROFILE

Profile for shelves and counter displays

Compact profile in natural anodised extruded aluminium for LED bar realizations.
 End caps included.
 Suitable for indoor use.
 Excellent heating dissipation.
 This profile can be used for many different purposes, such as wall or table signage, due to its etched methacrylate surface (display signs with diffused lighting).

For LED strip see Ch. 6 (LED lighting).

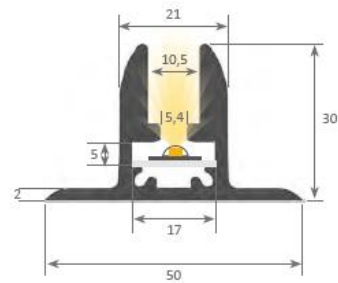

| Code | Description | | | | €/Pcs. |
|----------|-----------------|-----------|-----------------|------------|---------|
| | Type | Material | Colour | Pcs./Pack. | |
| LOZ2PG01 | Profile G - 3 m | Aluminium | Anodized Silver | 1 | € 69,72 |

| Accessories Code | Description | €/Pack. | Image |
|------------------|---|---------|---|
| LOZ2PGT/F | 10 pcs. package of aluminium end caps with fixing holes | € 29,83 |  |

STRIP LED PROFILES

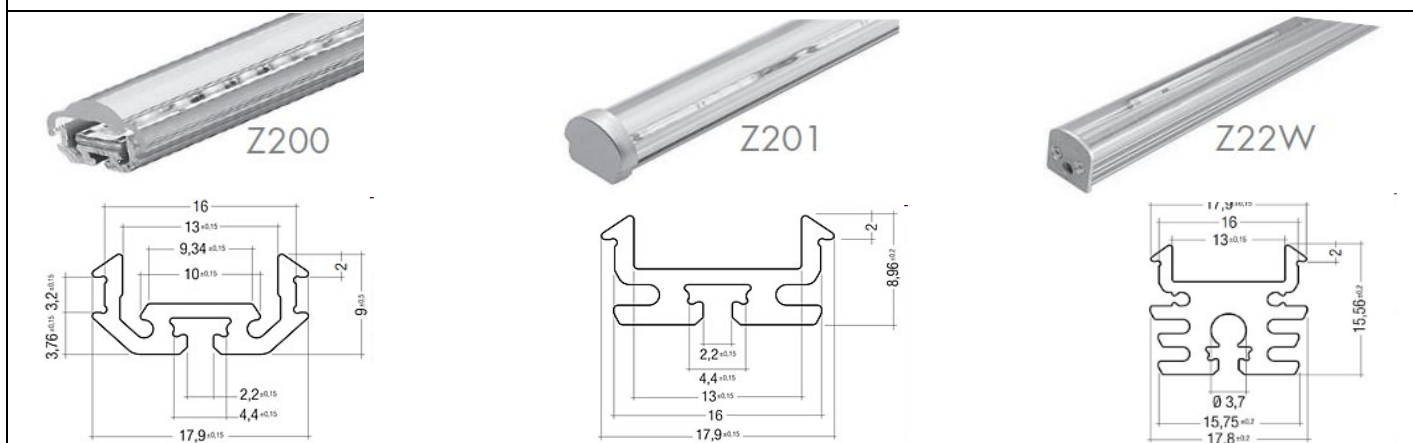

TALEXX Z200/Z201/Z22W PROFILES

Compact profile in natural anodised extruded aluminium for special LED systems realizations.

Suitable for indoor use.









Excellent heating dissipation.

Accessories set available: caps, lens, racks, diffusers, etc.

For LED strip see Ch. 6 (LED lighting).



| Code | Description | | | | €/Pcs. |
|--------|-------------------|-----------|-----------------|------------|---------|
| | Type | Material | Colour | Pcs./Pack. | |
| LOZ200 | TALEXX Z200 - 2 m | Aluminium | Anodized Silver | 1 | € 16,90 |
| LOZ201 | TALEXX Z201 - 2 m | Aluminium | Anodized Silver | 1 | € 15,20 |
| LOZ22W | TALEXX Z22W - 2 m | Aluminium | Anodized Silver | 1 | € 30,30 |

| Accessories Code | Description | €/Pack. | Image |
|----------------------------|--|-------------------------------|---|
| LOZ201T | Grey PMMA end cap (Z201) | € 0,50 |  |
| LOZ22WT | Aluminium end cap with hole for cable entry (Z22W) | € 1,70 |  |
| LOZ22WTF | Aluminium end cap without hole (Z22W) | € 1,70 |  |
| LOZ22WP | Adjustable fixing plate | € 3,00 |  |
| LOZ161 | Fixing plate (Z201) | € 0,90 |  |
| LOZ1P 15-30-45-60 | Fixing plate 15°- 30°- 45°- 60° | € 3,50 |  |
| LOZ00 30-60-90 | PMMA transparent lens 30°- 60°- 90° | € 16,40 |  |
| LOZ220 LOZ221 LOZ222 | PMMA transparent cover PMMA frosted cover PMMA white cover | € 10,00 € 10,80 € 11,70 |  |

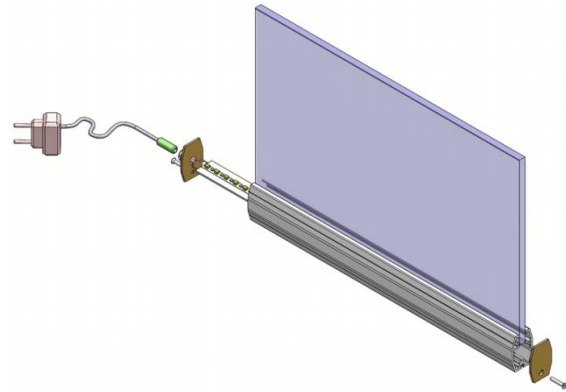
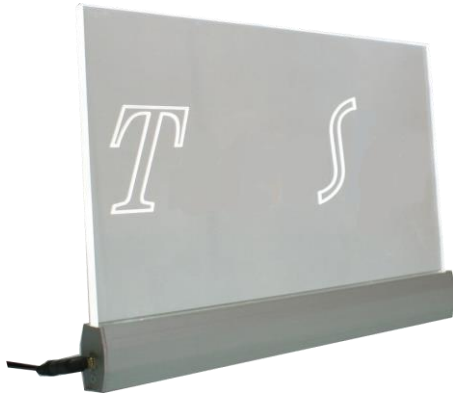



N2008 PROFILE

Compact profile in natural anodised extruded aluminium for special LED systems realizations.
 Suitable for indoor use.
 Excellent heating dissipation.
 End caps included.
 Suitable for filter-ray signs.
 Suitable for 8,5 mm PMMA sheets.

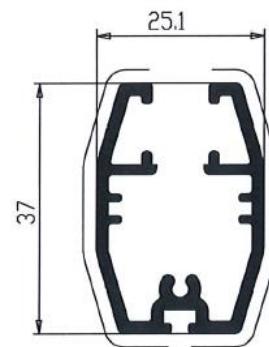
For LED strip see Ch. 6 (LED lighting).



| Code | Description | | | | €/Pcs. |
|------------|-------------|-----------|-----------------|---------|---------|
| | Type | Material | Colour | €/m | |
| OPUBL2008A | N2008 - 6 m | Aluminium | Anodized Silver | € 14,32 | € 85,92 |

| Accessories Code | Description | €/Pack. | Image |
|------------------|---------------------------------------|---------|---|
| OT2801 | End cap with or without hole | € 3,04 |  |
| OT2802 | Hanging end cap with or without hole | € 3,04 |  |
| OT2803 | Standing end cap with or without hole | € 3,04 |  |

CHANNEL LETTERS PROFILES

ALURAPID

Aluminium profile for easy and quick production of channel letters and lightboxes. Very light and highly flexible it enables to make letters with very sharp angles. A pneumatic machine enables also to the production of channel letters of large dimensions.

For rigid panels see Ch. 1 (plastic material).

For LED modules and power supplies see Ch. 6 (LED lighting).

ON DEMAND



JEWELITE F LETTER TRIM

Plastic mouldings with aluminium core that add new dimension to channel letters. No painting or polishing necessary. Fast fixturing with self tapping screws.

Suitable for use on 3 mm PMMA sheets.

For rigid panels see Ch. 1 (plastic material).

For LED modules and power supplies see Ch. 6 (LED lighting).





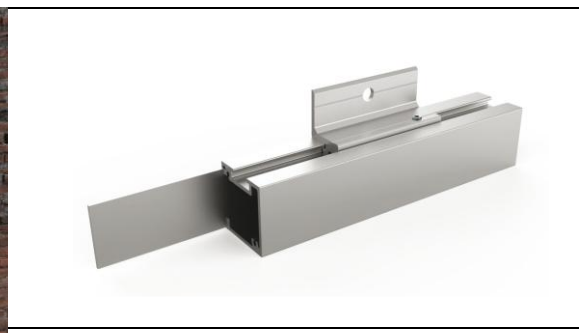

| Code | Description | | | | €/m |
|-------------------------------------|------------------------------|-----------|--------|---------|-----------|
| | Type | Material | Colour | m/Pack. | |
| KCHF25B | Trim Jewelite - 25 mm Height | Aluminium | White | 4 | ON DEMAND |
| KCHF25N | Trim Jewelite - 25 mm Height | Aluminium | Black | 4 | ON DEMAND |
| KCHF25R | Trim Jewelite - 25 mm Height | Aluminium | Red | 4 | ON DEMAND |
| KCHF25V | Trim Jewelite - 25 mm Height | Aluminium | Green | 4 | ON DEMAND |
| KCHF25BL | Trim Jewelite - 25 mm Height | Aluminium | Blue | 4 | ON DEMAND |
| KCHF25G | Trim Jewelite - 25 mm Height | Aluminium | Yellow | 4 | ON DEMAND |
| Angle-shaping accessories on demand | | | | | |

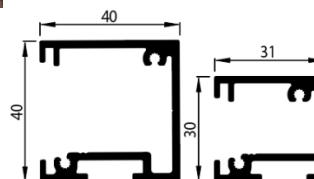

BOXLETTER CABLE CHANNEL

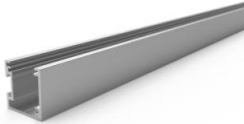
Practical wall mounting and wiring system for box letters. The cable channels are fixed to the wall by means of wall brackets, and can slide on them for optimal positioning. The letters are then fixed to the channel. The number of channels required is determined by the height of the letters. Fixing the cables within the aluminium cable duct increases reliability and safety, particularly with regard to fire propagation.

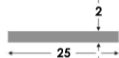

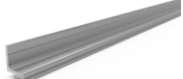
| Code | Description | | | €/m | €/Pc. | Picture |
|------------|-----------------------------------|-----------|-------------|-----------|---------|---|
| | Type | Material | Color | | | |
| ED200CC001 | Canal 30 mm Length: 6.1m | Aluminium | mill finish | 11,72 € | 71,48 € |  |
| ED200CC002 | Channel 40 mm Length: 6.1m | Aluminium | mill finish | 15,56 € | 94,92 € |  |
| ED200CC003 | End cap for 30 mm gutter | Aluminium | mill finish | | 6,62 € |  |
| ED200CC004 | End cap for 40 mm gutter | Aluminium | mill finish | | 6,74 € | |
| ED200CC005 | Flat bar 25x2 mm MT 6 | Aluminium | mill finish | ON DEMAND | |  |
| ED200CC006 | Flat bar 35x2 mm 6 m | Aluminium | mill finish | ON DEMAND | |  |
| ED200CC007 | Wall bracket for channel 80 mm | Aluminium | mill finish | | 5,23 € |  |
| ED200CC008 | Wall support profile 6.1 m | Aluminium | mill finish | 10,16 € | 62,00 € |  |

Customised cutting and painting/anodising in other colours on request