

CHAPTER

TWO

Communication Systems and Signage

			Updating	
Page 2.01	Aluminium Snap Frames		June	2025
Page 2.02	Aluminium Frames		March	2026
Page 2.03	Aluminium Frames for Posters		April	2023
Page 2.04	Notice Boards		September	2022
Page 2.05	Poster Stands		September	2022
Page 2.06	Info Boards		September	2022
Page 2.07	Portable Systems for Exhibitions and Meetings		September	2022
Page 2.08	Brochure Holders		September	2022
Page 2.09	Banners		May	2024
Page 2.10	Sidewalk Signs		January	2023
Page 2.11	Lightboxes and Illuminated Products		September	2022
Page 2.12	Stand-offs and Fixing Systems		May	2025
Page 2.15	Steel boxed edge plates with Fastenings		March	2026
Page 2.16	Aluminium boxed edge plates with Fastenings		March	2025
Page 2.17	Accessories plates with Fastenings		June	2025
Page 2.18	Steel boxed edge plates with Supports		March	2026
Page 2.19	Aluminium boxed edge plates with Supports		March	2026
Page 2.20	Accessories plates with Supports		June	2025
Page 2.21	Aluminium Single Side extruded plates		May	2024
Page 2.21A	Accessories for Single Side extruded plates		June	2025
Page 2.22	Aluminium Double Side extruded plates		April	2026
Page 2.22A	Accessories for Double Side extruded plates		June	2025

GENERAL SALES CONDITIONS

INTRODUCTION

All the hereunder conditions are intended and accepted for each order you send to us.

Prices do not include VAT and extra fees eventually needed. Any change in prices will be agreed before the delivery.

1. ORDERS

All orders are accepted and executed on the basis of the following conditions, which will govern future deliveries, even when not reproduced.

All orders should be sent to us by fax or e-mail. Except in case of different agreements, we will debt a fixed contribution of € 15,00.

= (as partial reimbursement for bank and customs fees).

2. DELIVERIES

Goods are delivered at the buyer's risk.

Quoted times for delivery are not binding. Buyers cannot refuse the goods or ask for a reimbursement in case of delayed delivery.

3. COMPLAINTS AND RETURN OF GOODS

The client must check the condition of the goods upon its arrival and, in case of damage, to take the proper actions.

Shortcomings in quantity and quality may be claimed in written form, within 8 days from the receipt of the goods.

If the claim is prompt and justified, Buyers have exclusively entitlement to replacement of the products.

Abatements as well as making good of direct or indirect loss shall not be possible.

4. PAYMENTS

If the customer defaults on the payment of an invoice or an installment, any and all other outstanding invoice amounts or installments shall immediately become due and payable. Consumers shall pay interest on the money debt during the time of default of € 25,00 plus a 7 points above the base rate. As far as Business Enterprises are concerned, we reserve the right to prove and claim a higher damage caused by the delay in payment.

In these cases, we will be unable to accept and execute any further orders until the settlement has been received.

5. TECHNICAL DATA

We reserve ourselves the right to modify the technical data stated, at any time and without notice.

On request, we will give assistance to the customers for the best use of the products, on the basis of available experience.

6. CONTROVERSIES

In case of lawsuits the competent court will be the one in Treviso.

7. PRIVACY

Our privacy policy updated in accordance with articles 13-14 of EU Regulations 2016/679 is available on our website www.cmngroup.eu, section "Conditions and Privacy".

ALUMINIUM SNAP FRAMES

Indoor applications suggested. Quotations for iron backings in outdoor applications.

SNAP FRAME

Wall snap frame with silver anodised aluminium profile, supplied with plastic backing and anti glare protection. Mitred corners or chrome round corners. Available profiles: 25 mm - 32 mm - 46 mm. Wall mounting accessories included.

	Code	Size mm.	Frame mm.	Corner	Description	€ / each
	EOSNA425A	DIN A4 297 x 210	25	Round	Snap Frame 25 DIN A4 297 x 210 Round	11,16
	EOSNA325A	DIN A3 420 x 297	25	Round	Snap Frame 25 DIN A3 420 x 297 Round	14,78
	EOSNA225A	DIN A2 594 x 420	25	Round	Snap Frame 25 DIN A2 594 x 420 Round	20,66
	EOSNA125A	DIN A1 841 x 594	25	Round	Snap Frame 25 DIN A1 841 x 594 Round	30,84
	EOSNAB25A	700 x 500	25	Round	Snap Frame 25 700 x 500 Round	24,88
	EOSNAC25A	1000 x 700	25	Round	Snap Frame 25 1000 x 700 Round	38,76

	Code	Size mm.	Frame mm.	Corner	Description	€ / each
	EOSNA425Q	DIN A4 297 x 210	25	Mitred	Snap Frame 25 DIN A4 297 x 210 Mitred	11,16
	EOSNA325Q	DIN A3 420 x 297	25	Mitred	Snap Frame 25 DIN A3 420 x 297 Mitred	14,78
	EOSNA225Q	DIN A2 594 x 420	25	Mitred	Snap Frame 25 DIN A2 594 x 420 Mitred	20,66
	EOSNA125Q	DIN A1 841 x 594	25	Mitred	Snap Frame 25 DIN A1 841 x 594 Mitred	30,84
	EOSNAB25Q	700 x 500	25	Mitred	Snap Frame 25 700 x 500 Mitred	24,88
	EOSNAC25Q	1000 x 700	25	Mitred	Snap Frame 25 1000 x 700 Mitred	38,76

	Code	Size mm.	Frame mm.	Corner	Description	€ / each
	EOSNA332A	DIN A3 420 x 297	32	Round	Snap Frame 32 DIN A3 420 x 297 Round	20,70
	EOSNA232A	DIN A2 594 x 420	32	Round	Snap Frame 32 DIN A2 594 x 420 Round	28,56
	EOSNA132A	DIN A1 841 x 594	32	Round	Snap Frame 32 DIN A1 841 x 594 Round	41,60
	EOSNAB32A	700 x 500	32	Round	Snap Frame 32 700 x 500 Round	34,04
	EOSNAC32A	1000 x 700	32	Round	Snap Frame 32 1000 x 700 Round	52,02
	EOSNAD32A	1400 x 1000	32	Round	Snap Frame 32 1400 x 1000 Round	80,88

	Code	Size mm.	Frame mm.	Corner	Description	€ / each
	EOSNA332Q	DIN A3 420 x 297	32	Mitred	Snap Frame 32 DIN A3 420 x 297 Mitred	20,70
	EOSNA232Q	DIN A2 594 x 420	32	Mitred	Snap Frame 32 DIN A2 594 x 420 Mitred	28,56
	EOSNA132Q	DIN A1 841 x 594	32	Mitred	Snap Frame 32 DIN A1 841 x 594 Mitred	41,60
	EOSNAB32Q	700 x 500	32	Mitred	Snap Frame 32 700 x 500 Mitred	34,04
	EOSNAC32Q	1000 x 700	32	Mitred	Snap Frame 32 1000 x 700 Mitred	52,02
	EOSNAD32Q	1400 x 1000	32	Mitred	Snap Frame 32 DIN 1400 x 1000 Mitred	80,88

SNAP FRAME MOUNTING KIT

Kit for creating tailored frames. Profiles are 32 mm wide and 3 meters long to cut according to the needs. Composed by profiles, connectors, corners, springs.

	Code	Description	€ / cad
	EOSN32PROF	Snap 32 mm Frames (lower and upper) - 3 m long - no Springs included.	18,32
	EOSNANCONF	Round Snap Corner, with Chrome Connector - Pack of 10 pcs	19,90
	EOSNCONF	Angular Connector - Pack of 10 pcs	8,28
	EOSNMOLF100	Steel Springs for 32 mm Snap Frames Profiles. Pack of 100 pcs	19,72

PRICES UPDATING
ASK FOR A QUOTE

ALUMINIUM FRAMES

WINDOW FRAME

25 and 32 mm silver colour extruded anodised aluminium snap frame for window applications. Mitred corners. Supplied with double-sided adhesive for the poster application and decorative profiles that hide the adhesive itself. It comes with 2 anti-glare PVC sheets, to display the "message" on both sides.



Code	Size mm.	Frame mm.	Corner	Description	€ / each
EOWFA425Q	DIN A4 297 x 210	25	Mitred	Window Frame 25 A4 Mitred	22,28
EOWFA325Q	DIN A3 420 x 297	25	Mitred	Window Frame 25 A3 Mitred	26,14
EOWFA225Q	DIN A2 420 x 297	25	Mitred	Window Frame 25 A2 Mitred	36,14
EOWFA125Q	DIN A1 420 x 297	25	Mitred	Window Frame 25 A1 Mitred	49,28
EOWFB25Q	700 x 500	25	Mitred	Window Frame 25 700 x 500 Mitred	60,38
EOWFA032Q	DIN A0 1188 x 841	32	Mitred	Window Frame 32 1188 x 841 Mitred	87,04
EOWFC32Q	1000 x 700	32	Mitred	Window Frame 32 1000 x 700 Mitred	85,16

SLIDE IN FRAME

Silver colour extruded anodised aluminium frame. Single or double-sided. Anti-glare PVC sheet. Comes with 4 screws for wall mounting. Portrait or landscape versions available.



Code	Size mm.	Orientation	Sides	Description	€ / each
EOSA4OVM	DIN A4 297 x 210	Port. / Land.	Single	Slide In Frame DIN A4 Single	14,66
EOSA3OVM	DIN A3 420 x 297	Port. / Land.	Single	Slide In Frame DIN A3 Single	18,74
EOSA2OVM	DIN A2 594 x 420	Port. / Land.	Single	Slide In Frame DIN A2 Single	25,86
EOSA1OVM	DIN A1 841 x 594	Port. / Land.	Single	Slide In Frame DIN A1 Single	40,52
EOSBOVM	700 x 500	Port. / Land.	Single	Slide In Frame DIN 700 x 500 Single	31,86
EOSCOVM	1000 x 700	Port. / Land.	Single	Slide In Frame DIN 1000 x 700 Single	52,10



Code	Size mm.	Orientation	Sides	Description	€ / each
EOSA4VB	DIN A4 297 x 210	Portrait	Double	Slide In Frame DIN A4 Portrait Double-sided	14,02
EOSA3VB	DIN A3 420 x 297	Portrait	Double	Slide In Frame DIN A3 Portrait Double-sided	17,50
EOSA2VB	DIN A2 594 x 420	Portrait	Double	Slide In Frame DIN A2 Portrait Double-sided	24,50
EOSA1VB	DIN A1 841 x 594	Portrait	Double	Slide In Frame DIN A1 Portrait Double-sided	34,22
EOSBVB	700 x 500	Portrait	Double	Slide In Frame DIN 700 x 500 Portrait Double-sided	29,76
EOSCVB	1000 x 700	Portrait	Double	Slide In Frame DIN 1000 x 700 Portrait Double-sided	49,02



Code	Size mm.	Orientation	Sides	Description	€ / each
EOSA4OB	DIN A4 297 x 210	Landscape	Double	Slide In Frame DIN A4 Land. Double-sided	14,12
EOSA3OB	DIN A3 420 x 297	Landscape	Double	Slide In Frame DIN A3 Land. Double-sided	17,68
EOSA2OB	DIN A2 594 x 420	Landscape	Double	Slide In Frame DIN A2 Land. Double-sided	24,72
EOSA1OB	DIN A1 841 x 594	Landscape	Double	Slide In Frame DIN A1 Land. Double-sided	34,56
EOSBOB	700 x 500	Landscape	Double	Slide In Frame DIN 700 x 500 Land. Double-sided	29,46
EOSCOB	1000 x 700	Landscape	Double	Slide In Frame DIN 1000 x 700 Land. Double-sided	49,48

SNAP SIGN

26 mm silver colour extruded anodised aluminium snap frame. Easy graphic change. Supplied with 1.3 mm polystyrene back panel and 1 mm PVC protection. Can be oriented vertically or horizontally. Fixation by adhesive tape or four drill holes for wall mounting.



Code	Size mm.	Frame mm	Sides	Description	€ / each
EOPSB	148 x 105	28	Single	Snap Sign mm 105 x 148	6,18
EOPSD	DIN A5 210 x 148	28	Single	Snap Sign A5 mm 210 x 148	8,38
EOPSE	DIN A4 297 x 210	28	Single	Snap Sign A4 mm 297 x 210	10,14
EOPSEF	DIN A3 420 x 297	28	Single	Snap Sign A3 mm 420 x 297	14,24

DELTA SIGN

Silver colour extruded anodised aluminium sign-holder. Easy graphic change. Can be used in different ways (portrait, landscape, ceiling suspension, etc). Available with a clear PVC sheet to secure inserts. Fixation by adhesive tape or four drill holes for wall mounting.



Code	Size mm.	Description	€ / each
EOPDS100	100 x 120	Delta Sign mm 100 x 120 Black Lids with double-sided adhesive and screw	10,66
EOPDS120	100 x 120	Delta Sign mm 120 x 120 Black Lids with double-sided adhesive and screw	12,90
EOPDS150	150 x 150	Delta Sign mm 150 x 150 Black Lids with double-sided adhesive and screw	17,40
EOPDS200	200 x 150	Delta Sign mm 200 x 150 Black Lids with double-sided adhesive and screw	22,32

Ask us for availability and special offers for bulk purchasing.

PRICES UPDATING
ASK FOR A QUOTE

ALUMINIUM FRAMES FOR POSTERS

POSTER SNAP

25 mm silver colour extruded anodised aluminium snap frame. One set includes top and bottom profiles. Bottom profile holds your graphic flat and tight. Lids and hooks for wall mounting or ceiling suspension included.

	Code	Size mm.	Description	€ / each
	EOPSN050	500	Poster Snap cm.50	11,38
	EOPSN060	594	Poster Snap cm.60	12,34
	EOPSN070	700	Poster Snap cm.70	13,66
	EOPSN085	841	Poster Snap cm.85	14,62
	EOPSN100	1000	Poster Snap cm.100	17,46
	EOPSN120	1200	Poster Snap cm.120	19,74
	EOPSN140	1400	Poster Snap cm.140	29,60
POSTER SNAP MOUNTING KIT				
	Code	Description		€ / each
	EOPSN310	Snap 25 mm Frames (lower and upper) - 3 m long - no Springs included.		21,04
	EOPSNF	Poster Snap Lids - Right / Left - Pack of 10 pcs		3,96
	EOPSNGAF	Poster Snap Hook - Pack of 10 pcs		3,96

POSTER CLAMP

32 mm silver colour extruded anodised aluminium snap frame. One set includes top and bottom profiles. The special profile guarantees a strong grip. Suitable for heavier and bigger posters. Hangers suitable for wall mounting or ceiling suspension.

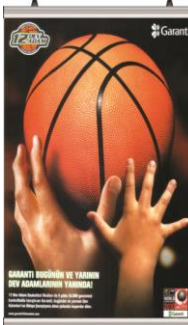
	Code	Size mm.	Description	€ / each
	EOPCL050	500	Poster Clamp cm.50	14,76
	EOPCL060	594	Poster Clamp cm.60	16,44
	EOPCL070	700	Poster Clamp cm.70	20,38
	EOPCL085	841	Poster Clamp cm.85	22,88
	EOPCL100	1000	Poster Clamp cm.100	27,90
	EOPCL120	1200	Poster Clamp cm.120	32,90
	EOPCL140	1400	Poster Clamp cm.140	36,00
POSTER CLAMP MOUNTING KIT				
	Code	Descrizione		€ / each
	EOPCL310	Snap 25 mm Frames (lower and upper) - 3 m long - no Springs included.		20,60
	EOPCLF	Poster Clamp Lids - Right / Left - Pack of 10 pcs		7,50
	EOPCLGA	Poster Clamp Hook - Pack of 10 pcs		6,40

POSTER FAST

Silver colour extruded anodised aluminium snap frame for posters, composed by 2 FAST rails with lateral opening for a quick and easy assembling. Supplied with plastic lids and hooks for wall mounting or ceiling suspension.

	Code	Size mm.	Description	€ / each
	EOPFA050	500	Poster Fast cm.50	10,14
	EOPFA060	594	Poster Fast cm.60	11,12
	EOPFA070	700	Poster Fast cm.70	12,56
	EOPFA085	841	Poster Fast cm.85	14,58
	EOPFA100	1000	Poster Fast cm.100	17,20
	EOPFA120	1200	Poster Fast cm.120	18,64

STRECH FRAME

Silver colour extruded anodised aluminium. Lightweight display frame stretching you poster from 4 corners. Can be used single or double-sided, either in portrait or landscape position. Ideal for shop windows. Screws for wall mounting included.

	Code	Size mm.	Description	€ / each
	EOPSTA4	DIN A4 (297 x 210)	Stretch Frame A4 297 x 210 mm	6,98
	EOPSTA3	DIN A3 (420 x 297)	Stretch Frame A3 420 x 297 mm	7,66
	EOPSTA2	DIN A2 (594 x 420)	Stretch Frame A2 594 x 420 mm	9,52
	EOPSTAB	700 x 500	Stretch Frame 700 x 500 mm	10,20
	EOPSTAC	1000 x 700	Stretch Frame 1000 x 700 mm	12,76

Ask us for availability and special offers for bulk purchasing.

PRICES UPDATING
ASK FOR A QUOTE

NOTICE BOARDS

MAGNETIC NOTICE BOARD

Silver colour extruded anodised aluminium notice board, with magnetic back wall to display your message. Hinged door opens 90 degrees, with 1 or 2 locks according to size plus KEYS to lock. Can be used in both portrait and landscape positions. Suitable for indoor and outdoor use.

	Code	Size mm.	Description	€ / each
	EOSMY1D2	328 x 738	Magnetic Notice Board 328 x 738	2 x A4 149,62
	EOSMY1D3	328 x 1058	Magnetic Notice Board 328 x 1058	3 x A4 199,26
	EOSMY2D1	558 x 418	Magnetic Notice Board 558 x 418	2 x A4 146,14
	EOSMY2D2	558 x 738	Magnetic Notice Board 558 x 738	4 x A4 196,96
	EOSMY2D3	558 x 1058	Magnetic Notice Board 558 x 1058	6 x A4 245,32
	EOSMY3D1	788 x 418	Magnetic Notice Board 788 x 418	3 x A4 186,94
	EOSMY3D2	788 x 738	Magnetic Notice Board 788 x 738	6 x A4 226,44
	EOSMY3D3	788 x 1058	Magnetic Notice Board 788 x 1058	9 x A4 280,78
	EOSMY3D4	788 x 1378	Magnetic Notice Board 788 x 1378	12 x A4 337,88
	EOSMY4D2	1018 x 738	Magnetic Notice Board 1018 x 738	8 x A4 264,42
EOSMY4D3	1018 x 1058	Magnetic Notice Board 1018 x 1058	12 x A4 325,26	

CORK NOTICE BOARD

Silver colour extruded anodised aluminium notice board, with natural cork back wall for use with pins. Hinged door opens 90 degrees, with 1 or 2 locks according to size plus KEYS to lock. Can be used in both portrait and landscape positions. Suitable for indoor and outdoor use.

	Code	Size mm.	Description	€ / each
	EOSSY1D2	328 x 738	Cork Notice Board 328 x 738	2 x A4 163,90
	EOSSY1D3	328 x 1058	Cork Notice Board 328 x 1058	3 x A4 226,46
	EOSSY2D1	558 x 418	Cork Notice Board 558 x 418	2 x A4 156,56
	EOSSY2D2	558 x 738	Cork Notice Board 558 x 738	4 x A4 230,80
	EOSSY2D3	558 x 1058	Cork Notice Board 558 x 1058	6 x A4 282,16
	EOSSY3D1	788 x 418	Cork Notice Board 788 x 418	3 x A4 202,36
	EOSSY3D2	788 x 738	Cork Notice Board 788 x 738	6 x A4 270,68
	EOSSY3D3	788 x 1058	Cork Notice Board 788 x 1058	9 x A4 314,52
	EOSSY3D4	788 x 1378	Cork Notice Board 788 x 1378	12 x A4 376,84
	EOSSY4D2	1018 x 738	Cork Notice Board 1018 x 738	8 x A4 294,26
EOSSY4D3	1018 x 1058	Cork Notice Board Board 1018 x 1058	12 x A4 357,42	

MAGNETIC MIDI NOTICE BOARD

Silver colour extruded anodised aluminium notice board, with magnetic back wall to display your message. Hinged door opens 90 degrees, with 1 or 2 locks according to size plus KEYS to lock. Can be used in both portrait and landscape positions. Suitable for indoor and outdoor use.

	Code	Size mm.	Description	€ / each
	EOSDMY5V2	1230 x 750	Notice Board Magnetic 1230 x 750	10 x A4 448,26
	EOSDMY4V3	990 x 1050	Notice Board Magnetic 990 x 1050	12 x A4 493,28
	EOSDMY5V3	1230 x 1050	Notice Board Magnetic 1230 x 1050	15 x A4 545,08
	EOSDMY6V3	1450 x 1050	Notice Board Magnetic 1450 x 1050	18 x A4 612,58
	EOSDMY7V3	1670 x 1050	Notice Board Magnetic 1670 x 1050	21 x A4 650,78

MIDI CORK NOTICE BOARD

Silver colour extruded anodised aluminium notice board, with natural cork back wall for use with pins. Hinged door opens 90 degrees, with 2 locks plus KEYS to lock. Can be used in both portrait and landscape positions. Suitable for indoor and outdoor use.

	Code	Size mm.	Description	€ / each
	EOSDCY5V2	1230 x 750	Notice Board Cork 1230 x 750	10 x A4 478,78
	EOSDCY4V3	990 x 1050	Notice Board Cork 990 x 1050	12 x A4 528,40
	EOSDCY5V3	1230 x 1050	Notice Board Cork 1230 x 1050	15 x A4 603,80
	EOSDCY6V3	1450 x 1050	Notice Board Cork 1450 x 1050	18 x A4 661,02
	EOSDCY7V3	1670 x 1050	Notice Board Cork 1670 x 1050	21 x A4 723,82

MAGNETIC BOARD DYNAMIC

Single pedestal display unit. 4 way post extrusion enabling different configurations. Weather resistant. Silver anodised aluminium frame and post. Lockable hinge front with acrylic safety glass. Magnetic back wall to display your messages. Galvanised steel base.

	Code	Size mm.	Description	€ / each
	EOSMLY2D2	580 x 760	Single Leg Magnetic Showboard 580 x 760	4 x A4 367,78
	EOSMLY2D3	580 x 1080	Single Leg Magnetic Showboard 580 x 1080	6 x A4 416,62

Ask us for availability and special offers for bulk purchasing.

PRICES UPDATING
ASK FOR A QUOTE

POSTER STANDS

POSTER STAND

Silver colour extruded anodised aluminium structure. 2 poles stand 1 or 2 snap frames (single-sided or double-sided) completed with non-glare PVC protection. On request, available acrylic shelves as accessories. NB: check page 2.11 for the illuminated version.

	Code	Size mm.	Description	€ / each
	EOIB5070	700 x 500	Poster Stand Single-sided 700 x 500 mm	147,42
	EOIB1070	1000 x 700	Poster Stand Single-sided 1000 x 700 mm	180,74
	EOIB8560	841 x 594	Poster Stand Single-sided 841 x 594 mm	159,50
	EOIB5070B	700 x 500	Poster Stand Double-sided 700 x 500 mm	182,70
	EOIB1070B	1000 x 700	Poster Stand Double-sided 1000 x 700 mm	236,72
	EOIB8560B	841 x 594	Poster Stand Double-sided 841 x 594 mm	203,94
ACCESSORIES				
Code	Size mm.	Description	€ / each	
EOIBCEST2	2 x A4	Acrylic Shelf / Single-sided 4mm 2 x A4	32,58	
EOIBCEST3	3 x A4	Acrylic Shelf / Single-sided 4mm 3 x A4	47,10	
EOIBCEST4	4 x A4	Acrylic Shelf / Single-sided 4mm 4 x A4	62,70	



INFO POSTER STAND

Silver colour extruded anodised aluminium structure, composed by 2 poles and 2 snap frames (25 mm wide single-sided and 32 mm double-sided) featuring non-glare PVC protection for multi-directional advertising. MDF base.

	Code	Size mm.	Description	€ / each
	EOIPSM1	841 x 594	Info Poster Stand Single-sided 841 x 594	156,48
	EOIPSMB2	700 x 500	Info Poster Stand Single-sided 700 x 500	150,92
	EOIPSMB1	1000 x 700	Info Poster Stand Single-sided 1000 x 700	167,74
	EOIPSBA1	841 x 594	Info Poster Stand Double-sided 841 x 594	188,12
	EOIPSBB2	700 x 500	Info Poster Stand Double-sided 700 x 500	175,82
	EOIPSBB1	1000 x 700	Info Poster Stand Double-sided 1000 x 700	205,62

FREE STANDING LEAFLET DISPLAY

Unique design featuring fully adjustable components. Multi-functional display combining snap frames with brochure holders. 2 or 4 ways post enabling different configuration. Can be single or double-sided. All the structure is made of silver colour extruded anodised aluminium.

	Code	Size mm.	Description	€ / each	
	EOSNASBR	(Round base) Diam: 450 (Oval post) L: 70 - H: 1920 (Squared base) - Side: 360	Oval FreeStanding post + Round Base + Lid	153,84	
	EOSNASBQ	(Rectang. post) H: 900 + 900	Rectangular FreeStanding Post + Squared Base + Lid	124,52	
	EOSNASA1	DIN A1 (841 x 594)	FreeStanding Frame 25 mm A1 841 x 594 mm	33,40	
	EOSNASB2	DIN B2 (700 x 500)	FreeStanding Frame 25 mm B2 700 x 500 mm	27,44	
	EOSNASB1	DIN B1 (1000 x 700)	FreeStanding Frame 25 mm B1 1000 x 700 mm	41,88	
	EOSNAS32B1	DIN B1 (1000 x 700)	FreeStanding Frame 32 mm B1 1000 x 700 mm	49,30	
	EOSNASRA5ML	DIN A5	Metal Shelf for Free Standing A5 - LATERAL	17,98	
	EOSNASRA4M	DIN A4 (297 x 210)	Metal Shelf for Free Standing A4 - LATERAL	24,10	
	EOSNASRA3M	DIN A3 (2 x A4)	Metal Shelf for Free Standing A3 (2 x A4) - FRONT	44,26	
	EOSNASDSH	300 x 210	Header Delta System 300 x 210 mm	69,98	
					<p>ATTENTION: to process the order properly, it is necessary to choose all the options:</p> <ul style="list-style-type: none"> • Post + Base • Frames (optional) • Shelves (optional) • Header (optional)

Ask us for availability and special offers for bulk purchasing.

PRICES UPDATING
ASK FOR A QUOTE

INFOBOARDS

CLASSIC INFOBOARD (DECO BASE)

A classic design featuring A4 or A3 snap frames with mitred or round corners. Both portrait and landscape positioning of the snap frames are allowed. Silver colour extruded anodised aluminium pole, frames and baseplate.

	Code	Size mm.	Description	€ / each
	EOMBA4A	DIN A4 (297 x 210)	Classic Infoboard A4 297 x 210 mm Round	55,50
	EOMBA4Q	DIN A4 (297 x 210)	Classic Infoboard A4 297 x 210 mm Mitred	55,50
	EOMBA3A	DIN A3 (420 x 297)	Classic Infoboard A3 420 x 297 mm Round	69,00
	EOMBA3Q	DIN A3 (420 x 297)	Classic Infoboard A3 420 x 297 mm Mitred	69,00

ADJUSTABLE INFOBOARD

Freestanding display unit made of silver colour extruded anodised aluminium. Create your own info board by adding snap frames (landscape and portrait positioning allowed) and brochure holders. Powder coated steel baseplate.

	Code	Size mm.	Description	€ / each
	EORAA4	DIN A4 (297 x 210)	Adjustable Infoboard A4 297 x 210 mm Round	73,96
	EORA3	DIN A3 (420 x 297)	Adjustable Infoboard A3 420 x 297 mm Round	84,60
	ACCESSORIES			
		Code	Size mm.	Description
	EORAA4	DIN A4 (297 x 210)	Additional Snap Frame A4 297 x 210 mm with Connector	10,60
	EORAA3	DIN A3 (420 x 297)	Additional Snap Frame A3 420 x 297 mm with Connector	15,30
	EORA4CEST	DIN A4 (297 x 210)	Acrylic Shelf for Adjustable Infoboard 1 x A4	13,50
	EORA4CESTA	DIN A4 (297 x 210)	Steel Shelf for Adjustable Infoboard 1 x A4	12,00

BELT BARRIES

Easy to assemble path mark, ribbon length 2300 mm, pole color black, height 940 mm, base diameter 360 mm, pole diameter 64 mm, weight 11 kg, colored ribbon on 4 outputs

	Codice	Dimensioni mm.	Descrizione	€ / cad
	EOCBK	940 x 360	Black pole with black ribbon	102,78
	EOCBR	940 x 360	Black pole with red ribbon	102,78



Ask us for availability and special offers for bulk purchasing.

PRICES UPDATING
ASK FOR A QUOTE

PORTABLE SYSTEMS FOR EXHIBITIONS AND MEETINGS

FOLDING COUNTER

Collapsible, convex or hexagonal counter. Fully foldable panels with 18mm thick laminate countertop and thick laminate inner shelf. Main structure in silvercolour extruded anodised aluminium. Easily transported (bag included) and assembled without tools. Graphics panels are interchangeable.

	Code	Size mm.	Description	€ / each
	EOBCM70	F: 720 x 920 S: 320 x 920	Wood Counter Convex + Bag 720 X 920	209,44
	EOBCB70	F: 720 x 920 S: 320 x 920	White Counter Convex + Bag 720 X 920	209,44
	EOBCM90	F: 920 x 920 S: 420 x 920	Wood Counter Convex + Bag 920 X 920	238,56
	EOBCB90	F: 920 x 920 S: 420 x 920	White Counter Panset Convex + Bag 920 X 920	238,56
	EOBCBE70	F: 760 x 920	White Counter Hexagonal + Bag	385,80

F: Front S: Side T: Top

PROMOTION DESK

An extremely cost effective demonstrator unit that is lightweight, portable and simple to assemble. Apply your promotional graphics as vinyls or screen print directly onto the plastic base wrap and header. Suitable for indoor and outdoor use. Supplied with carry bag.

	Code	Size mm.	Description	€ / each
	EOSTD	D: 1465 x 800 L: 810 x 250	White Promotion desk with Header + Bag	176,88

D: Desk L: Logo

BROCHURE HOLDERS

PYRAMID STAND

Free standing display unit with 20 x 40 mm box profile. Durable and elegant with 7 mm thick brushed aluminium stainless baseplate. Integrated Delta Sign header to display logos or additional info. 3 mm thick clear acrylic shelves.

	Code	Size mm.	Sides	Description	€ / each
	EOPBSM3	H: 1493 3 x A4	Single	Pyramid Stand Single-side 3 x A4	127,00
	EOPBSM4	H: 1493 4 x A4	Single	Pyramid Stand Single-side 4 x A4	136,46
	EOPBSB6	H: 1493 6 x A4	Double	Pyramid Stand Double-side 6 x A4	159,42
	EOPBSB8	H: 1493 8 x A4	Double	Pyramid Stand Double-side 8 x A4	175,48

Ask us for availability and special offers for bulk purchasing.

PRICES UPDATING
 ASK FOR A QUOTE

BROCHURE HOLDERS

BROCHURE STAND

Free standing display with silver colour anodised aluminium structure. Simple but functional design. Stable T foot system. 4 mm thick clear acrylic shelves.

	Code	Size mm.	Sides	Description	€ / each
	EOBR36A4M	535 X 1770 X 400	Single	Brochure Stand 3 Shelves 6 x A4 Single	210,44
	EOBR39A4M	735 X 1770 X 400	Single	Brochure Stand 3 Shelves 9 x A4 Single	279,22
	EOBR312A4M	950 X 1770 X 400	Single	Brochure Stand 3 Shelves 12 x A4 Single	329,26
	EOBR48A4M	535 X 1770 X 400	Single	Brochure Stand 4 Shelves 8 x A4 Single	241,38
	EOBR412A4M	735 X 1770 X 400	Single	Brochure Stand 4 Shelves 12 x A4 Single	323,96
	EOBR416A4M	950 X 1770 X 400	Single	Brochure Stand 4 Shelves 16 x A4 Single	388,80
	EOBR312A4B	535 X 1770 X 400	Double	Brochure Stand 3 Shelves 12 x A4 Double	301,22
	EOBR318A4B	735 X 1770 X 400	Double	Brochure Stand 3 Shelves 18 x A4 Double	354,16
	EOBR324A4B	950 X 1770 X 400	Double	Brochure Stand 3 Shelves 24 x A4 Double	486,72
EOBR416A4B	535 X 1770 X 400	Double	Brochure Stand 3 Shelves 24 x A4 Double	359,26	
EOBR424A4B	735 X 1770 X 400	Double	Brochure Stand 3 Shelves 24 x A4 Double	438,28	
EOBR432A4B	950 X 1770 X 400	Double	Brochure Stand 3 Shelves 24 x A4 Double	581,10	





ACRYLIC BROCHURE STAND

Functional brochure stand made of silver colour anodised aluminium profile and A4 or 2 x A4 4 mm thick clear acrylic folder. Suitable for displaying your brochures in public areas like hotels, showrooms, shops, etc. Landscape or portrait versions available.

	Code	Size mm.	Description	€ / each
	EODBSVA4	h: 1000	Decorative Brochure Stand A4 Portrait	89,86
	EODBSOA3	h: 1000	Decorative Brochure Stand A3 Portrait	106,48

LEAFLET DISPENSER

Leaflet dispenser made of clear acrylic 3 mm thick. Different versions, shapes and sizes available: freestanding, wall mounting, T shape, etc.

	Code	Size mm.	€ / each		Code	Size mm.	€ / each
	EOPA41/3	1/3 A4 210 x 110	2,22		EOPA41/3WM	1/3 A4 210 x 110	3,30
	EOPA5	DIN A5 210 x 150	2,88		EOPA5WM	DIN A5 210 x 150	4,58
	EOPA4	DIN A4 297 x 210	4,72		EOPA4WM	DIN A4 297 x 210	7,42
	ORIZZONTALE				HORIZONTAL		
	EOPA5T0	DIN A5 210 x 150	4,56		EOPA5L	DIN A5 210 x 150	4,52
	EOPA4T0	DIN A4 297 x 210	7,72		EOPA4L	DIN A4 297 x 210	8,84
	VERTICAL				VERTICAL		
	EOPA5TV	DIN A5 150 x 210	4,56		EOPA5LT	DIN A5 150 x 210	4,64
	EOPA4TV	DIN A4 210 x 297	7,72		EOPA4LT	DIN A4 210 x 297	8,06

Ask us for availability and special offers for bulk purchasing.

PRICES UPDATING
ASK FOR A QUOTE

BANNERS

ROLLBANNER CHROME

Single-sided roller banner. Silver colour anodised snap frame profiles.

	Code	Size mm.	Description	€ / each
	EOCBC85	850 x 2000	Rollbanner Chrome 850	on demand
	EOCBC100	1000 x 2000	Rollbanner Chrome 1000	on demand

ECO ROLLER

Eco version of single-sided roller banner chrome. Silver colour anodised snap frame profiles. Carry bag included.

	Code	Size mm.	Description	€ / each
	EOCRBMS085	850 x 2050	Eco Rollbanner 850	36,80
	EOCRBMSN100	1000 x 2050	Eco Rollbanner 1000	50,40

QUICK BANNER

Single-sided banner. Silver colour anodised snap frame profiles. Lightweight, flexible and mobile system, easy to use clamping profile to fix your banner. Optional hard bag available.

	Code	Size mm.	Description	€ / each
	EOQBM60	600 x 2000	Quick Banner Single 600 x 2000	30,98
	EOQBM70	700 x 2000	Quick Banner Single 700 x 2000	32,48
	EOQBM80	800 x 2000	Quick Banner Single 800 x 2000	34,52
	EOQBM100	1000 x 2000	Quick Banner Single 1000 x 2000	37,62
	EOQBBO90	banner fino a 900 mm	Carry Bag for QuickBanner within 900 mm	20,02
	EOQBBO100	banner fino a 1000 mm	Carry Bag for QuickBanner within 1000 mm	23,10

BASE MOON

Couple of metal plates to support single sided or double sided panels of different sizes. Max panel thickness: 19 mm. Max height: 2000 mm. Lockable with 2 screws.



	Code	Size mm.	Description	€ / each
	DBMOON30	Width: 300	Base Moon 30 cm	66,00
	DBMOON50	Width: 500	Base Moon 50 cm	80,00
	DBMOON70	Width: 700	Base Moon 70 cm	92,00

Ask us for availability and special offers for bulk purchasing.

PRICES UPDATING
ASK FOR A QUOTE

SIDEWALK SIGNS

ABOARD

	32 mm double-sided sidewalk sign made of silver colour anodised aluminium snap frame. 20 x 30 mm standing profiles. Water resistant. Optional logo-holder and metallic leaflet dispenser.				
	Code	Size mm.	Corner	Description	€ / each
	EOFBA1	DIN A1 (841 x 594)	Round	A-Board 841 x 594 mm Round	116,98
	EOFBAB	700 x 500	Round	A-Board 700 x 500 mm Round	103,16
	EOFBAC	1000 x 700	Round	A-Board 1000 x 700 mm Round	119,14
	EOFBAD	1400 x 1000	Round	A-Board 1400 x 1000 mm Round	182,44
	EOFBA1Q	DIN A1 (841 x 594)	Mitred	A-Board 841 x 594 mm Mitred	116,98
	EOFBABQ	700 x 500	Mitred	A-Board 700 x 500 mm Mitred	103,16
	EOFBACQ	1000 x 700	Mitred	A-Board 1000 x 700 mm Mitred	119,14
	EOFBADQ	1400 x 1000	Mitred	A-Board 1400 x 1000 mm Mitred	182,44
	ACCESSORIES				
	Code	Size mm.	Description	€ / each	
	EOFBPLP	1 X A4	Logo Holder A-Board PVC	16,00	
EOFBCA4	2 X A4	Metal leaflet dispenser A-Board A4	16,68		

CURVE STEEL A-BOARD

	Double-sided poster display with semicircle top plate for business logo. Steel construction. Powder coated A-Frame. 25 mm diameter tubing. Magnetic edge cover ensures clean, dry posters. Weatherproof UV stable anti-glare PVC magnetic cover sheets.			
	Code	Size mm.	Description	€ / each
	EOIRBA1	DIN A1 (841 x 594)	Curve Steel A-Board 841 x 594 mm	175,70
	EOIRB7050	700 x 500	Curve Steel A-Board 700 x 500 mm	156,66
	EOIRB1070	1000 x 700	Curve Steel A-Board 1000 x 700 mm	225,04

POWER SWING

	Double sided sidewalk sign made of silver colour anodised aluminium profile with an easy poster inserting system. Steel springs provide flexibility to keep it stable. Suitable for windy outdoor conditions. Heavy and long feet on the base provide stability.			
	Code	Size mm.	Description	€ / each
	EOSWA1	DIN A1 (841 x 594)	Swing A1 841 x 594 mm	218,60
	EOSW50	700 x 500	Swing 700 x 500 mm	195,68
	EOSW70	1000 x 700	Swing 1000 x 700 mm	248,50
	EOSW100	1400 x 1000	Swing 1400 x 1000 mm	397,60

POSTER SWING WATER BASE

	External pavement sign with a water or sand filled base. High quality springs guarantee stability even in windy conditions. Wheels attached to the base allow easy manoeuvring in all conditions. Aluminium snap frame poster capture.			
	Code	Size mm.	Description	€ / each
	EOEA1	DIN A1 (841 x 594)	Poster Swing water base 841 x 594 mm	279,50
	EOE0705	700 x 500	Poster Swing water base 700 x 500 mm	254,08
	EOE1070	1000 x 700	Poster Swing water base 1000 x 700 mm	301,80
	EOE1410	1400 x 1000	Poster Swing water base 1400 x 1000 mm	480,24

PS BOARD

	Pavement sign made of plastic. Economic and weatherproof sign.			
	Code	Size mm.	Description	€ / each
	EOFBBB	880 x 500	PS-Board 880 x 500 mm white	60,98

Ask us for availability and special offers for bulk purchasing.

PRICES UPDATING
ASK FOR A QUOTE

LIGHTBOXES AND ILLUMINATED DISPLAYS

LED FRAME

LED powered light box with adequate brightness and little maintenance. No hotspots or shadows. PET protection sheet. The snap open allows an easy poster change.

SIGLE SIDED				
Code	Size mm.	Illumination	Description	€ / each
EOSLA4	DIN A4 297 x 210	3200-4200	Smart LED Box 297 X 210	81,88
EOSLA3	DIN A3 420 x 297	3000-4000	Smart LED Box 420 X 297	103,96
EOSLA2	DIN A2 594 x 420	2800-3600	Smart LED Box 594 X 420	183,90
EOSLA1	DIN A1 841 x 594	2600-3400	Smart LED Box 841 X 594	225,00
EOSLB2	DIN B2 700 x 500	2200-3000	Smart LED Box 700 X 500	263,70
EOSLB1	DIN B1 1000 x 700	2000-2300	Smart LED Box 1000 X 700	342,00
DOUBLE SIDED				
Code	Size mm.	Illumination	Description	€ / each
	DIN A4 297 x 210	3200-4200	Smart LED Box 297 X 210	
	DIN A3 420 x 297	3000-4000	Smart LED Box 420 X 297	
	DIN A2 594 x 420	2800-3600	Smart LED Box 594 X 420	
	DIN A1 841 x 594	2600-3400	Smart LED Box 841 X 594	
	DIN B2 700 x 500	2200-3000	Smart LED Box 700 X 500	
	DIN B1 1000 x 700	2000-2300	Smart LED Box 1000 X 700	



DELTA LIGHT BOX *

Single-sided indoor lightbox with snap open profiles for easy poster change. Suitable for both portrait and landscape position. Completely ready for connection. Backlit with 1 or 2 fluorescent tubes.

Code	Size mm.	Illumination	Description	€ / each
EOCLA2	DIN A2 594 x 420	1 x 15W	Delta Light Box A2	167,96
EOCLA1	DIN A1 841 x 594	2 x 18W	Delta Light Box A1	237,46
EOCLB2	DIN B2 700 x 500	2 x 18W	Delta Light Box B2	190,22
EOCLB1	DIN B1 1000 x 700	2 x 30W	Delta Light Box B1	316,36



* WEEE (RAEE) FEE NOT INCLUDED.



Ask us for availability and special offers for bulk purchasing.

PRICES UPDATING
ASK FOR A QUOTE

STAND-OFFS AND FIXING SYSTEMS

MIX ALU

Wall stand-offs in painted aluminium complete of anchor bolts, screws and allen wrench.

Picture	Code	Size mm.		Max sheet width mm.	Colour	Package	Description	€ / package
		Stand-off Width	Wall Depth					
	DCABASA	13	13	5	Silver	4 Pcs	Mix Alu Small Stand-off 13x13 Silver	11,60
	DCABAMA	13	20	12	Silver	4 Pcs	Mix Alu Medium Stand-off 13x20 Silver	15,46
	DCABAMN	13	20	12	Black	4 Pcs	Mix Alu Medium Stand-off 13x20 Black	17,78
	DCABALN	18	18	20	Nero	4 Pz	Mix Alu Large Stand-off 18x18 Black	18,80

RAPID



Wall stand-offs in painted ABS complete of anchor bolts, screws and allen wrench.

MADE IN ITALY 

Picture	Code	Size mm.		Max sheet width mm.	Colour	Package	Description	€ / package
		Stand-off Width	Wall Depth					
	DCABES13	18	23	10	Chrome	40 Pcs	Rapid Chrome	9,60
	DCABES19	18	23	10	Gold	40 Pcs	Rapid Gold	11,52

FISSO

Wall stand-offs in brass complete of anchor bolts, screws and allen wrench.

Picture	Code	Size mm.		Max sheet width mm.	Colour	Package	Description	€ / package
		Stand-off Width	Wall Depth					
	DCABMINIO	15	6	4	Gold	8 Pcs	Fisso Mini Stand-off Gold	50,36
	DCABMINIC	15	6	4	Chrome	8 Pcs	Fisso Mini Stand-off Chrome	36,42
	DCABMINIA	15	6	4	Silver	8 Pcs	Fisso Mini Stand-off Silver	52,00
	DCABMIDIO	15	21	10	Gold	4 Pcs	Fisso Midi Stand-off Gold	26,44
	DCABMIDIC	15	21	10	Chrome	4 Pcs	Fisso Midi Stand-off Chrome	19,74
	DCABMIDIA	15	21	10	Silver	4 Pcs	Fisso Midi Stand-off Silver	21,70
	DCABMAXIO	25	25	15	Gold	4 Pcs	Fisso Maxi Stand-off Gold	61,68
	DCABMAXIC	25	25	15	Chrome	4 Pcs	Fisso Maxi Stand-off Chrome	46,72
	DCABMAXIA	25	25	15	Silver	4 Pcs	Fisso Maxi Stand-off Silver	60,78

FISSO KLIPSER

KLIPSER pressure to be glued to the panel and fasten to the wall

Picture	Code	Depth	Diameter	Colour	Package	Description	€ / package
	DCABKL1515	15	15 mm	Transparent	10 Pcs.	Klipser spacer D 15x15	8,80
	DCABKL2020	20	20 mm	Transparent	10 Pcs.	Klipser spacer D 20x20	10,70
	DCABKL2030	30	20 mm	Transparent	10 Pcs.	Klipser spacer D 20x30	11,00

*The dimensions reported here are referring to those of the klipser together with the trasparent cap

FIXING SYSTEM WITH FRAMES

Fixing systems for aluminium snap frames. It allows ceiling suspension or wall mounting. Consists in snap frame, steel wires, hooks and clamps.

Picture	Code	Double-sided frame with 25 mm width profile		€ / each
		Size mm.	Description	
	EOSNA425QB	DIN A4 210 x 297	Double Sided Snap Frame 25 A4 Mitred	27,94
	EOSNA325QB	DIN A3 297 x 420	Double Sided Snap Frame 25 A3 Mitred	34,18
	EOSNA225QB	DIN A2 420 x 594	Double Sided Snap Frame 25 A2 Mitred	44,78
	EOSNB225QB	DIN B2 500 x 700	Double Sided Snap Frame 25 B2 Mitred	52,12
	EOSNA125QB	DIN A1 594 x 841	Double Sided Snap Frame 25 A1 Mitred	62,58
	EOSNB125QB	DIN B1 700 x 1000	Double Sided Snap Frame 25 B1 Mitred	75,52
	EOSNA025QB	DIN A0 841 x 1188	Double Sided Snap Frame 25 A0 Mitred	93,30
	EOSNB025QB	DIN B0 1000 x 1400	Double Sided Snap Frame 25 B0 Mitred	115,46
	EOMFKIT	Standard suspension kit Wire + Hooks		15,60
	DFLY00	Fly Lean Perla		6,80
	EOSNS	Hooks for Ceiling suspension and Wass mounting for Snap Frame		19,70

Ask us for availability and special offers for bulk purchasing.

ROAD SIGN PLATES

STEEL BOXED EDGE PLATES WITH FASTENINGS

The plates are for signaling and they are stored in iron boxes, resting against one another. It is therefore very probable and frequent that the paint is streaked during the warehouses movements.

Being designed for road signs these tables are always sanded and completely covered with film, they are not born to be worked directly on the painted surface.

For these reasons we can not guarantee the integrity and perfection in the painting.

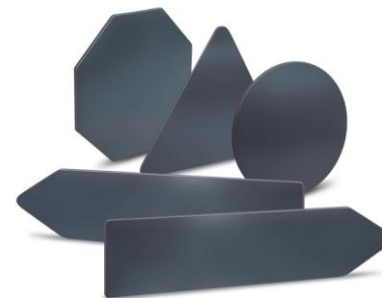

Code	Description				€/Pack.
	Type HxB	Material	Colour	Pcs./Pack.	
E03110031	Plate 15x35 - 1 fast.	Steel	Dark Grey	1	€ 7,85
E03110085	Plate 17x33 - 1 fast.	Steel	Dark Grey	1	€ 8,68
E03110121	Plate 18x53 - 1 fast.	Steel	Dark Grey	1	€ 13,33
E03110201	Plate 20x40 - 1 fast.	Steel	Dark Grey	1	€ 9,40
E03110301	Plate 20x80 - 1 fast.	Steel	Dark Grey	1	€ 16,80
E03110404	Plate 20x100 - 4 fast.	Steel	Dark Grey	1	€ 19,53
E03110490	Plate 25x25 - 2 fast.	Steel	Dark Grey	1	€ 6,93
E03110601	Plate 25x50 - 2 fast.	Steel	Dark Grey	1	€ 11,33
E03110751	Plate 25x80 - 2 fast.	Steel	Dark Grey	1	€ 17,15
E03110854	Plate 25x100 - 4 fast.	Steel	Dark Grey	1	€ 21,90
E0311091	Plate 25x125 - 4 fast.	Steel	Dark Grey	1	€ 26,28
E03110981	Plate 27x80 - 2 fast.	Steel	Dark Grey	1	€ 15,70
E03111201	Plate 30x60 - 2 fast.	Steel	Dark Grey	1	€ 25,00
E03111540	Plate 35x15 - 1 fast.	Steel	Dark Grey	1	€ 7,85
E03111701	Plate 40x40 - 2 fast.	Steel	Dark Grey	1	€ 14,43
E0311175	Plate 40x60 - 4 fast.	Steel	Dark Grey	1	€ 18,25
E03112213	Plate 50x25 - 2 fast.	Steel	Dark Grey	1	€ 12,60
E03112951	Plate 60x60 - 2 fast.	Steel	Dark Grey	1	€ 23,18
E03113104	Plate 60x90 - 4 fast.	Steel	Dark Grey	1	€ 39,78
E06110592 *	Plate 200x300 - 6 reinf.	Steel	Dark Grey	1	€ 711,75
E01110011	Triangle 60x60x60 - 2 fast.	Steel	Dark Grey	1	€ 13,15
E1110051	Triangle 90x90x90 - 2 fast.	Steel	Dark Grey	1	€ 22,45
E0222003	Disk Ø 40 - 2 fast.	Steel	Dark Grey	1	€ 13,15
E02110031	Disk Ø 60 - 2 fast.	Steel	Dark Grey	1	€ 21,73
E0522060220	Octagon Ø 60 - 2 fast.	Steel	Dark Grey	1	€ 23,00

*Supplied in 2 pieces, screws and nuts not included

Other colours on demand

ROAD SIGN PLATES

ALU BOXED EDGE PLATES WITH FASTENINGS

The plates are for signaling and they are stored in iron boxes, resting against one another. It is therefore very probable and frequent that the paint is streaked during the warehouses movements.

Being designed for road signs these tables are always sanded and completely covered with film, they are not born to be worked directly on the painted surface.

For these reasons we can not guarantee the integrity and perfection in the painting.

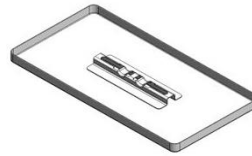

Code	Description				€/Pack.
	Type HxB	Material	Colour	Pcs./Pack.	
E03220050	Plate 15x35 - 1 fast.	Aluminium	Dark Grey	1	€ 11,23
E03220052	Plate 17x33 - 1 fast.	Aluminium	Dark Grey	1	€ 10,05
E03220055	Plate 18x53 - 1 fast.	Aluminium	Dark Grey	1	€ 18,35
E03220201	Plate 20x40 - 1 fast.	Aluminium	Dark Grey	1	€ 15,33
E03220404	Plate 20x100 - 4 fast.	Aluminium	Dark Grey	1	€ 36,50
E03220590	Plate 25x25 - 1 fast.	Aluminium	Dark Grey	1	€ 18,43
E03220601	Plate 25x50 - 2 fast.	Aluminium	Dark Grey	1	€ 22,45
E03220751	Plate 25x80 - 2 fast.	Aluminium	Dark Grey	1	€ 30,65
E3224954	Plate 25x125 - 4 fast.	Aluminium	Dark Grey	1	€ 46,00
E03220981	Plate 27x80 - 2 fast.	Aluminium	Dark Grey	1	€ 30,30
E03221201	Plate 30x60 - 2 fast.	Aluminium	Dark Grey	1	€ 28,48
E03221550	Plate 35x15 - 1 fast.	Aluminium	Dark Grey	1	€ 11,23
E03221701	Plate 40x40 - 2 fast.	Aluminium	Dark Grey	1	€ 25,93
E03222701R	Rhomb 40x40 - 2 fast.	Aluminium	Dark Grey	1	€ 32,30
E0322175	Plate 40x60 - 4 fast.	Aluminium	Dark Grey	1	€ 36,50
E0322218	Plate 50x25 - 2 fast.	Aluminium	Dark Grey	1	€ 23,90
E03222951	Plate 60x60 - 2 fast.	Aluminium	Dark Grey	1	€ 44,73
E03222702R	Rhomb 60x60 - 2 fast.	Aluminium	Dark Grey	1	€ 52,20
E03223104	Plate 60x90 - 4 fast.	Aluminium	Dark Grey	1	€ 69,53
E01220011	Triangle 60x60x60 - 2 fast.	Aluminium	Dark Grey	1	€ 28,30
E1220051	Triangle 90x90x90 - 2 fast.	Aluminium	Dark Grey	1	€ 43,25
E0222001	Disk Ø 40 - 2 fast.	Aluminium	Dark Grey	1	€ 28,30
EFCVDISC	Disk Ø 60 - 2 fast.	Aluminium	Dark Grey	1	€ 43,63
E0522060219	Octagon Ø 60 - 2 fast.	Aluminium	Dark Grey	1	€ 42,90

Other colours on demand

ACCESSORIES PLATES WITH FASTENINGS

Accessories Code	Description	€/Pcs.	Image
E11100130	Ø 48 bracket for pole	€ 0,93	
E1110015	Ø 60 bracket for pole	€ 1,00	
E11100160	Ø 90 bracket for pole	€ 1,83	
E1100190	35 mm 8 MA screw with nut	€ 0,30	
EFCV148D	Ø 48 double bracket for pole	€ 4,38	
E1100280	Ø 60 double bracket for pole	€ 4,75	
ES48300A	3 m of Ø 48 antirotation pole	€ 44,35	
ES48360A	3,6 m of Ø 48 antirotation pole	€ 53,29	
ES60300AR	3 m of Ø 60 antirotation pole	€ 48,09	
ES60360	3,6 m of Ø 60 antirotation pole	€ 57,67	
E10100001	Ø 48 pole cap PHASE OUT	€ 0,25	
E1010000	Ø 60 pole cap PHASE OUT	€ 0,50	
E10200060	Ø 60 Plug-in black rubber cap for pole	€ 0,50	

ROAD SIGN PLATES

STEEL BOXED EDGE PLATES WITH SUPPORTS

The plates are for signaling and they are stored in iron boxes, resting against one another. It is therefore very probable and frequent that the paint is streaked during the warehouses movements.

Being designed for road signs these tables are always sanded and completely covered with film, they are not born to be worked directly on the painted surface.

For these reasons we can not guarantee the integrity and perfection in the painting.

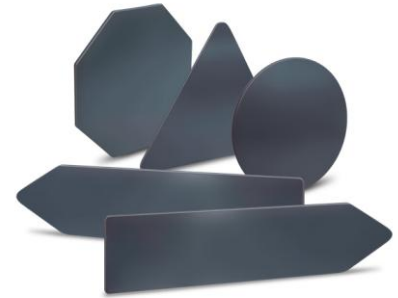

Code	Description				€/Pack.
	Type HxB	Material	Colour	Pcs./Pack.	
E03110912	Plate 25x125 - 2 supp.	Steel	Dark Grey	1	€ 39,78
E03111351	Plate 30x90 - 1 supp.	Steel	Dark Grey	1	€ 29,75
E03111203	Plate 30x130 - 2 supp.	Steel	Dark Grey	1	€ 44,53
E03111532	Plate 30x150 - 2 supp.	Steel	Dark Grey	1	€ 54,75
E03111582	Plate 35x105 - 2 supp.	Steel	Dark Grey	1	€ 37,60
E03111591	Plate 35x125 - 2 supp.	Steel	Dark Grey	1	€ 45,45
E03114812	Plate 50x125 - 2 supp.	Steel	Dark Grey	1	€ 59,30
E03112552	Plate 50x150 - 2 supp.	Steel	Dark Grey	1	€ 70,28
E03113252	Plate 60x120 - 2 supp.	Steel	Dark Grey	1	€ 67,15
E03113582	Plate 60x240 - 2 supp.	Steel	Dark Grey	1	€ 146,93
E03113652	Plate 70x150 - 2 supp.	Steel	Dark Grey	1	€ 85,95
E03114303	Plate 90x90 - 2 supp.	Steel	Dark Grey	1	€ 60,05
E03114403	Plate 90x120 - 4 supp.	Steel	Dark Grey	1	€ 89,98
E03114405	Plate 90x135 - 4 supp.	Steel	Dark Grey	1	€ 94,00
E03114605	Plate 100x150 - 5 supp.	Steel	Dark Grey	1	€ 125,03
E03114730	Plate 120x120 - 3 supp.	Steel	Dark Grey	1	€ 121,90
E03114956	Plate 150x200 - 5 supp.	Steel	Dark Grey	1	€ 281,98
E06110672 *	Plate 200x200 - 6 supp.	Steel	Dark Grey	1	€ 469,20
E1110054	Triangle 120x120x120 - 2 supp.	Steel	Dark Grey	1	€ 48,38
E02110032	Disk Ø 90 - 2 supp.	Steel	Dark Grey	1	€ 50,38
E04110122	Arrow 30x130 - 2 supp.	Steel	Dark Grey	1	€ 37,43
E04110252	Arrow 40x150 - 2 supp.	Steel	Dark Grey	1	€ 56,95
E0511090229	Octagon Ø 90 - 2 supp.	Steel	Dark Grey	1	€ 36,50

*Supplied in 2 pieces, screws and nuts not included

Other colours on demand

ROAD SIGN PLATES

ALU BOXED EDGE PLATES WITH SUPPORTS

The plates are for signaling and they are stored in iron boxes, resting against one another. It is therefore very probable and frequent that the paint is streaked during the warehouses movements.

Being designed for road signs these tables are always sanded and completely covered with film, they are not born to be worked directly on the painted surface.

For these reasons we can not guarantee the integrity and perfection in the painting.

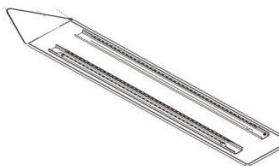

Code	Description				€/Pack.
	Type HxB	Material	Colour	Pcs./Pack.	
E3220912	Plate 25x125 - 2 supp.	Aluminium	Dark Grey	1	€ 64,98
E03220854	Plate 25x100 - 2 reinf.	Aluminium	Dark Grey	1	€ 58,40
E03221447	Plate 30x130 - 2 supp.	Aluminium	Dark Grey	1	€ 80,30
E03221532	Plate 30x150 - 2 supp.	Aluminium	Dark Grey	1	€ 85,78
E03221581	Plate 35x105 - 2 supp.	Aluminium	Dark Grey	1	€ 65,15
E03221590	Plate 35x125 - 2 supp.	Aluminium	Dark Grey	1	€ 84,50
E03224812	Plate 50x125 - 2 supp.	Aluminium	Dark Grey	1	€ 106,95
E0322255	Plate 50x150 - 2 supp.	Aluminium	Dark Grey	1	€ 125,20
E03223252	Plate 60x120 - 2 supp.	Aluminium	Dark Grey	1	€ 119,55
E03223257	Plate 60x240 - 2 supp.	Aluminium	Dark Grey	1	€ 266,45
E03223748	Plate 70x150 - 2 supp.	Aluminium	Dark Grey	1	€ 150,75
E3224955	Plate 70x200 - 2 supp.	Aluminium	Dark Grey	1	€ 225,20
E03224090	Plate 90x90 - 2 supp.	Aluminium	Dark Grey	1	€ 113,88
E03224405	Plate 90x120 - 4 supp.	Aluminium	Dark Grey	1	€ 164,25
E03224420	Plate 90x135 - 4 supp.	Aluminium	Dark Grey	1	€ 175,38
E0322460	Plate 100x150 - 2 supp.	Aluminium	Dark Grey	1	€ 209,33
E0322465	Plate 100x150 - 4 supp.	Aluminium	Dark Grey	1	€ 224,65
E3224953	Plate 100x200 - 2 supp.	Aluminium	Dark Grey	1	€ 330,70
E03224742	Plate 120x120 - 2 supp.	Aluminium	Dark Grey	1	€ 206,95
E3224952	Plate 150x200 - 3 supp.	Aluminium	Dark Grey	1	€ 492,75
E03224956	Plate 150x200 - 5 supp.	Aluminium	Dark Grey	1	€ 520,85
E06220672 *	Plate 200x200 - 4 supp.	Aluminium	Dark Grey	1	€ 731,83
E3224950 *	Plate 200x300 - 4 supp.	Aluminium	Dark Grey	1	€ 1.096,83
E1220054	Triangle 120x120x120 - 2 supp.	Aluminium	Dark Grey	1	€ 92,90
E02220010	Disk Ø 90 - 2 supp.	Aluminium	Dark Grey	1	€ 94,90
E04220122	Arrow 30x130 - 2 supp.	Aluminium	Dark Grey	1	€ 71,90
E04220252	Arrow 40x150 - 2 supp.	Aluminium	Dark Grey	1	€ 96,55
E0522090229	Octagon Ø 90 - 2 supp.	Aluminium	Dark Grey	1	€ 98,93

*Supplied in 2 pieces, screws and nuts not included

Other colours on demand

ACCESSORIES PLATES WITH SUPPORTS

Accessories Code	Description	€/Pack.	Image
E11100130	Ø 48 bracket for pole	€ 0,93	
E1110015	Ø 60 bracket for pole	€ 1,00	
E11100160	Ø 90 bracket for pole	€ 1,83	
E12100230	Ø 8 small bracket for support	€ 0,55	
E11100300 PHASE OUT	Bracket for basement inversion	€ 17,33	
E1100190	35 mm 8 MA screw with nut	€ 0,30	
EFCV148D	Ø 48 double bracket for pole	€ 4,38	
E1100280	Ø 60 double bracket for pole	€ 4,75	
ES48300A	3 m of Ø 48 antirotation pole	€ 44,35	
ES48360A	3,6 m of Ø 48 antirotation pole	€ 53,29	
ES60300AR	3 m of Ø 60 antirotation pole	€ 48,09	
ES60360	3,6 m of Ø 60 antirotation pole	€ 57,67	
E10100001	Ø 48 pole cap PHASE OUT	€ 0,25	
E1010000	Ø 60 pole cap PHASE OUT	€ 0,50	
E10200060	Ø 60 Plug-in black rubber cap for pole	€ 0,50	

ROAD SIGN PLATES

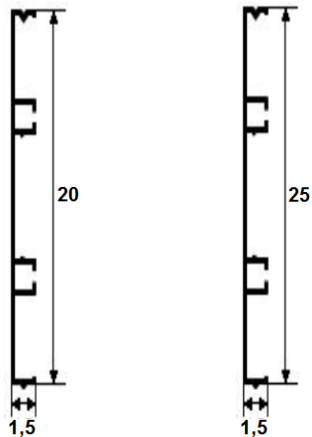





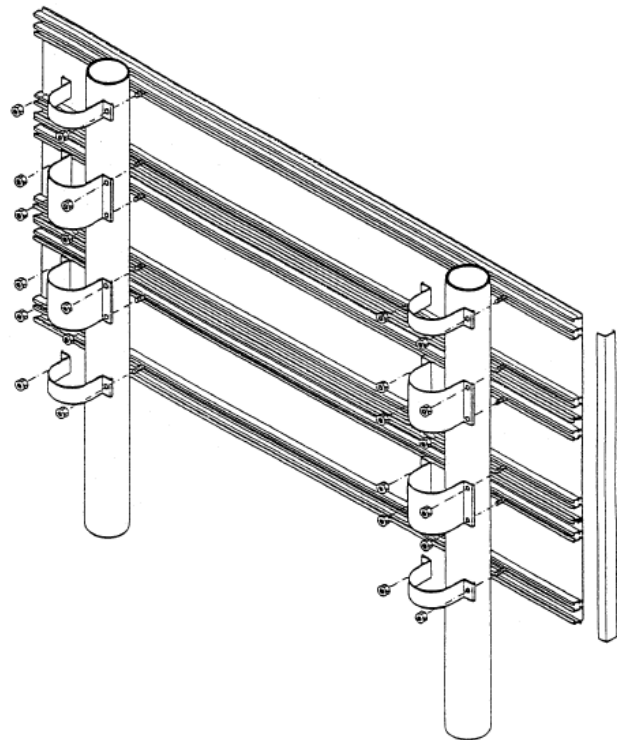

SINGLE SIDE EXTRUDED PLATES

Extruded single-sided aluminium plates and related accessories suitable for vertical road signs and urban design.



Code	Description				€/Pack.
	Type BxH	Material	Colour	Pcs./Pack.	
EFCV1620	Plate 100x20 - 2 supp.	Aluminium	Mill Finish	1	€ 52,20
EFCV163N	Plate 100x20 - 2 supp.	Aluminium	Black	1	€ 68,33
EFCV1620/125	Plate 125x20 - 2 supp.	Aluminium	Mill Finish	1	€ 74,00
EFCV1620/125N	Plate 125x20 - 2 supp.	Aluminium	Black	1	€ 87,43
EFCV1620GR	Plate 610x20 - 2 supp.	Aluminium	Mill Finish	1	€ 318,35
EFCV1620N	Plate 610x20 - 2 supp.	Aluminium	Black	1	€ 416,78
EFCV1625	Plate 125x25 - 2 supp.	Aluminium	Mill Finish	1	€ 82,18
EFCV1625N	Plate 125x25 - 2 supp.	Aluminium	Black	1	€ 97,80
EFCV1631	Plate 150x25 - 2 supp.	Aluminium	Mill Finish	1	€ 101,75
EFCV1631N	Plate 150x25 - 2 supp.	Aluminium	Black	1	€ 121,18
EFCV1625A	Plate 630x25 - 2 supp.	Aluminium	Mill Finish	1	€ 435,88
EFCV1625AN	Plate 630x25 - 2 supp.	Aluminium	Black	1	€ 517,78

ACCESSORIES FOR SINGLE SIDE EXTRUDED PLATES

Accessories Code	Description	€/Pack.	Image
EFCV1608/10	Ø 48 bracket for pole	€ 3,30	
EFCV1609/10	Ø 60 bracket for pole	€ 4,25	
EFCV1615/10	Ø 90 bracket for pole	€ 5,25	
EFCV1680	Double side Ø 60 bracket for pole	€ 11,25	
OBB135	Square-head screw 13x13 mm 8ma + bulb	€ 0,35	
ES48300A	3 m of Ø 48 antirotation pole	€ 44,35	
ES48360A	3,6 m of Ø 48 antirotation pole	€ 53,29	
ES60300AR	3 m of Ø 60 antirotation pole	€ 48,09	
ES60360	3,6 m of Ø 60 antirotation pole	€ 57,67	
E10100001	Ø 48 pole cap PHASE OUT	€ 0,25	
E1010000	Ø 60 pole cap PHASE OUT	€ 0,50	

The installer has the responsibility to assess the safety conditions for the exposure.

ROAD SIGN PLATES

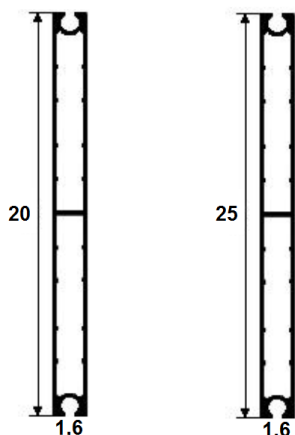

DOUBLE SIDE EXTRUDED PLATES

Extruded double-sided aluminium plates and related accessories suitable for vertical road signs and urban design.

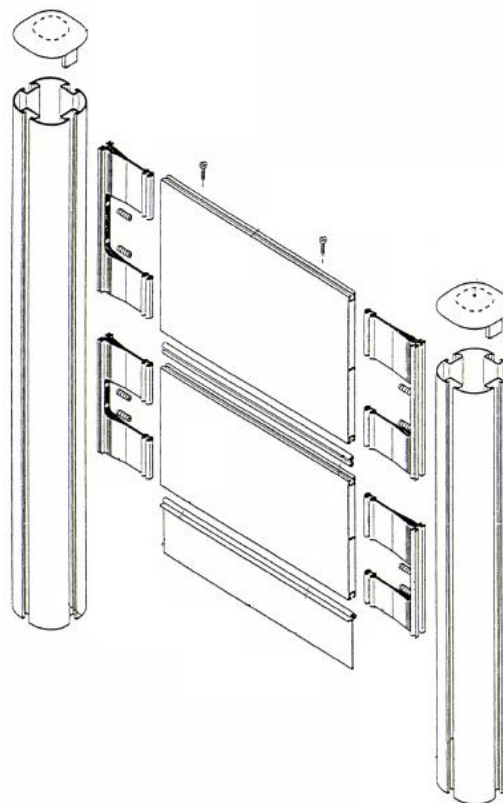

Code	Description				€/Pack.
	Type BxH	Material	Colour	Pcs./Pack.	
EFCV1503	Plate 100x20	Aluminium	Mill Finish	1	€ 96,50
EFCV1503N	Plate 100x20	Aluminium	Black	1	€ 112,55
EFCV1503A	Plate 650x20	Aluminium	Mill Finish	1	€ 627,25
EFCV1503AN	Plate 650x20	Aluminium	Black	1	€ 731,58
EFCV1504	Plate 125x25	Aluminium	Mill Finish	1	€ 128,38
EFCV1504V	Plate 125x25	Aluminium	Black	1	€ 153,30
EFCV16306	Plate 610x20	Aluminium	Mill Finish	1	€ 588,65
EFCV16306N	Plate 610x20	Aluminium	Black	1	€ 686,55

The installer has the responsibility to assess the safety conditions for the exposure.

ACCESSORIES FOR DOUBLE SIDE EXTRUDED PLATES

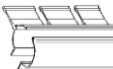
Accessories Code	Description	€/Pack.	Image
EFCV1802V	6 m four way 80 mm pole (it can be cut)	€ 649,80	
EFCV1761	Four way 80 mm pole cap	€ 6,50	
EFCV1519/20	Lateral closing cap for 20 double-sided plates	€ 6,00	
EFCV1519/25	Lateral closing cap for 25 double-sided plates	€ 6,25	
EFCV1705/20	Four way H 20 pole bracket	€ 23,25	
EFCV1705/25	Four way H 25 pole bracket	€ 26,38	
ES60300AR	3 m of Ø 60 antirotation pole	€ 48,09	
ES60360	3,6 m of Ø 60 antirotation pole	€ 57,67	
E1010000	Ø 60 pole cap PHASE OUT	€ 0,50	
EFCV1508	Four way height 20 pole bracket	€ 24,83	
EFCV1509	Four way height 25 pole bracket	€ 30,63	
OBB145	Painted iron screw with nut	€ 0,35	

The installer has the responsibility to assess the safety conditions for the exposure.